

6

5

4

3

2

1

APPROVED: \_\_\_\_\_

DATE: \_\_\_\_\_ TITLE: \_\_\_\_\_

Rev	AWO #	Description	Date	Appr
-----	-------	-------------	------	------

SEE SHT 1 OF 2 FOR REVISION

### SHORT SHELL

### LONG SHELL

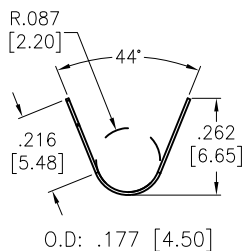
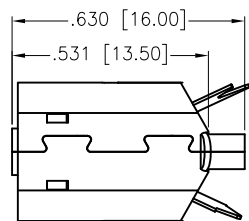
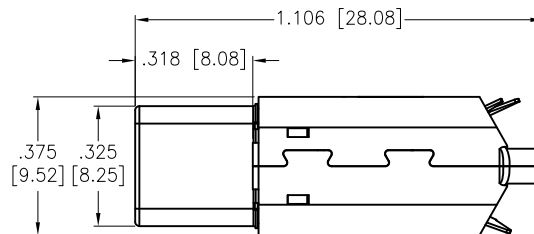
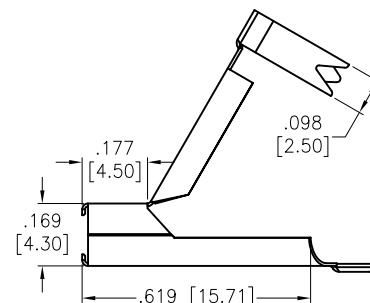
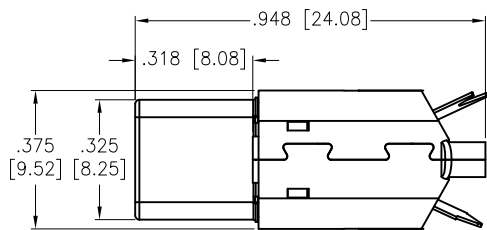
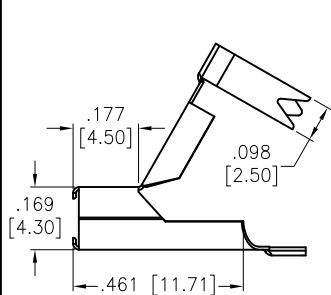

USB-C31-PLUG-B-S1-BK

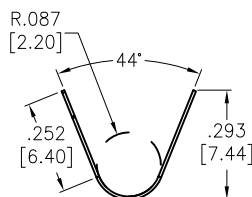

USB-C31-PLUG-B-S2-BK

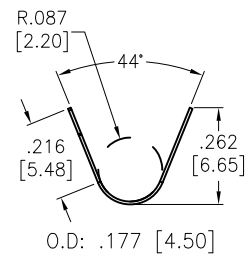
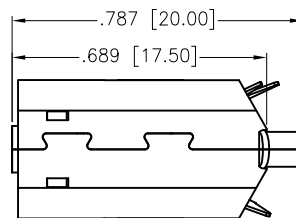

USB-C31-PLUG-B-L1-BK

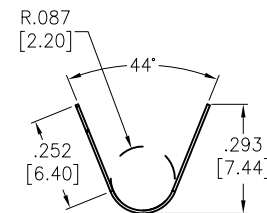

USB-C31-PLUG-B-L2-BK

UNLESS OTHERWISE SPECIFIED  
 ALL DIMENSIONS ARE INCHES [MM]  
 TOLERANCES: EXCEPT AS NOTED  
 INCHES HOLES  
 .X ± .10 Ø.X ± .10  
 .XX ± .020 Ø.XX ± .015  
 .XXX ± .015 Ø.XXX ± .010

## ADAM TECH

909 Rahway Avenue, Union, NJ 07083  
Phone: 908-687-5000 Fax: 908-687-5710

TITLE UNIVERSAL SERIAL BUS, TYPE C, MALE PLUG,  
STRADDLE MOUNT, BLACK INSULATOR

APPROVALS		DATE
DRAWN	HR	5/6/16
CHECKED	MW	5/6/16
APPROVED		

SIZE X	PART NO. USB-C31-PLUG-B-XX-BK	REV. -
REF: S00097C	SCALE: NTS	SHEET 2 OF 2

6

5

4

3

2

1