

SPECIFICATION FOR APPROVAL

REF. :

PROD. NAME	SMD Power Inductor	ABC'S DWG NO.	SR0302□□□□L□-□□□		
		REV.	20160719-F	PAGE	1

I . Configuration and dimensions :

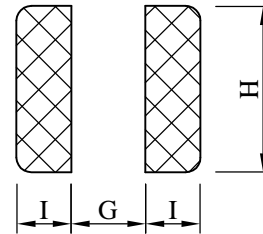
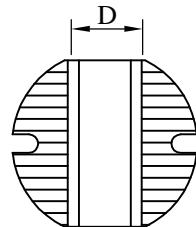
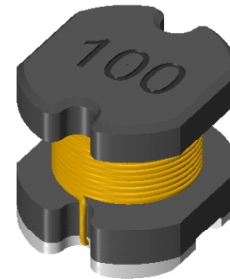
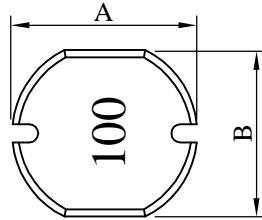

(PCB Pattern)

Unit : m/m

A	B	C	D	G	H	I
3.00±0.3	2.80±0.3	2.50±0.3	0.90 typ.	0.80 ref.	3.00 ref.	1.40 ref.

II . Description :

- a . Ferrite drum core construction.
- b . Enamelled copper wire : H class
- c . Product weight : 0.080g (ref.)
- d . Moisture sensitivity Level 1
- e . Products comply with RoHS' requirements
- f . Halogen free available

Peak Temp : 260°C max.
Max. Peak Temp - 5°C : 30sec max.
Max time above 217°C : 60sec~150sec max.

III . General specification :

- a . Storage temp. : -40°C ----+125°C
- b . Operating temp. : -40°C ----+125°C
(Temp. rise included.)
- c . Resistance to solder heat : 260°C.10 secs.

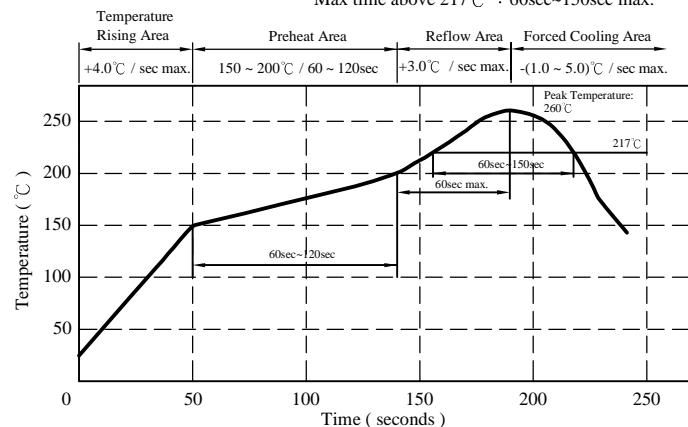

AR-001C

SPECIFICATION FOR APPROVAL

REF. :

PROD. NAME	SMD Power Inductor	ABC'S DWG NO.	SR0302□□□□L□-□□□		
		REV.	20160719-F	PAGE	2

IV . Electrical characteristics :

DWG No.	Inductance (μH)	Q ref.	Test Freq.		SRF (MHz) typ.	RDC (Ω) max.	Irms (A) max.	Isat (A) typ.
			L (Hz)/0.1V	Q (MHz)				
SR03021R0ML□-□□□	1.0±20%	20	100k	7.96	125.0	0.06	2.100	2.700
SR03021R2ML□-□□□	1.2±20%	22	100k	7.96	100.0	0.07	2.000	2.500
SR03021R5ML□-□□□	1.5±20%	23	100k	7.96	95.0	0.07	1.900	2.300
SR03021R8ML□-□□□	1.8±20%	23	100k	7.96	85.0	0.08	1.800	2.000
SR03022R2ML□-□□□	2.2±20%	22	100k	7.96	75.0	0.09	1.650	1.850
SR03022R7ML□-□□□	2.7±20%	22	100k	7.96	72.0	0.10	1.500	1.700
SR03023R3ML□-□□□	3.3±20%	23	100k	7.96	68.0	0.11	1.400	1.600
SR03023R9ML□-□□□	3.9±20%	24	100k	7.96	50.0	0.12	1.300	1.500
SR03024R7ML□-□□□	4.7±20%	18	100k	7.96	45.0	0.15	1.200	1.350
SR03025R6ML□-□□□	5.6±20%	18	100k	7.96	42.0	0.16	1.100	1.300
SR03026R8ML□-□□□	6.8±20%	18	100k	7.96	40.0	0.18	1.000	1.200
SR03028R2ML□-□□□	8.2±20%	16	100k	7.96	35.0	0.20	0.900	1.050
SR0302100ML□-□□□	10.0±20%	18	100k	2.52	34.0	0.25	0.800	0.900
SR0302120ML□-□□□	12.0±20%	15	100k	2.52	33.0	0.28	0.750	0.850
SR0302150ML□-□□□	15.0±20%	20	100k	2.52	32.0	0.40	0.650	0.800
SR0302180ML□-□□□	18.0±20%	18	100k	2.52	28.0	0.46	0.580	0.750
SR0302220ML□-□□□	22.0±20%	23	100k	2.52	22.0	0.66	0.520	0.650
SR0302270ML□-□□□	27.0±20%	23	100k	2.52	20.0	0.75	0.480	0.550
SR0302330KL□-□□□	33.0±10%	20	100k	2.52	18.0	0.85	0.420	0.500
SR0302390KL□-□□□	39.0±10%	24	100k	2.52	18.0	1.12	0.380	0.450
SR0302470KL□-□□□	47.0±10%	23	100k	2.52	17.0	1.27	0.360	0.400
SR0302560KL□-□□□	56.0±10%	18	100k	2.52	16.0	1.45	0.340	0.350
SR0302680KL□-□□□	68.0±10%	24	100k	2.52	14.0	1.85	0.300	0.320
SR0302820KL□-□□□	82.0±10%	24	100k	2.52	12.0	2.10	0.280	0.300
SR0302101KL□-□□□	100.0±10%	40	100k	0.796	10.0	2.85	0.260	0.280
SR0302121KL□-□□□	120.0±10%	40	100k	0.796	10.0	3.20	0.220	0.250
SR0302151KL□-□□□	150.0±10%	38	100k	0.796	9.0	4.60	0.200	0.230
SR0302181KL□-□□□	180.0±10%	45	100k	0.796	8.5	5.00	0.185	0.210
SR0302221KL□-□□□	220.0±10%	40	100k	0.796	8.0	5.70	0.170	0.190
SR0302271KL□-□□□	270.0±10%	45	100k	0.796	7.0	8.60	0.150	0.170
SR0302331KL□-□□□	330.0±10%	40	100k	0.796	6.0	10.00	0.130	0.150
SR0302391KL□-□□□	390.0±10%	40	100k	0.796	5.5	10.80	0.120	0.140
SR0302471KL□-□□□	470.0±10%	42	100k	0.796	5.0	14.30	0.105	0.130
SR0302561KL□-□□□	560.0±10%	43	100k	0.796	4.8	16.00	0.095	0.120
SR0302681KL□-□□□	680.0±10%	43	100k	0.796	4.3	18.00	0.085	0.110
SR0302821KL□-□□□	820.0±10%	45	100k	0.796	4.0	22.50	0.080	0.100
SR0302102KL□-□□□	1000.0±10%	40	100k	0.252	3.2	26.00	0.070	0.090
SR0302122KL□-□□□	1200.0±10%	40	100k	0.252	3.0	30.00	0.060	0.080

- 1). □ : Packaging information : □ Code
- 2). "-□□□" : Reference code
- 3). Electrical specifications at 25°C
- 4). Isat base on ΔL/L0A=10% typ.
- 5). Irms base on Temp. rise 40°C max.

AR-001C



SPECIFICATION FOR APPROVAL

REF. :

PROD. NAME	SMD Power Inductor	ABC'S DWG NO.	SR0302□□□□L□-□□□		
		REV.	20160719-F	PAGE	3

V . Curve :

SR03021R0ML□

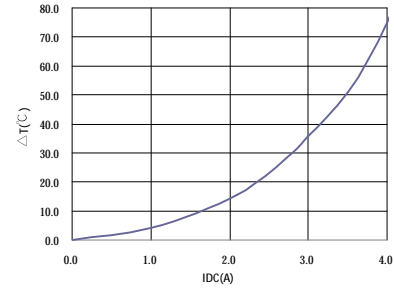
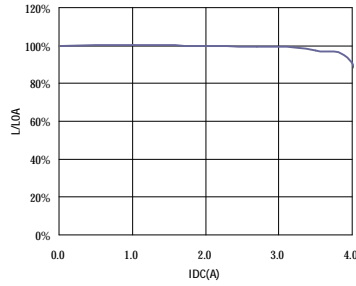

SR0302100ML□

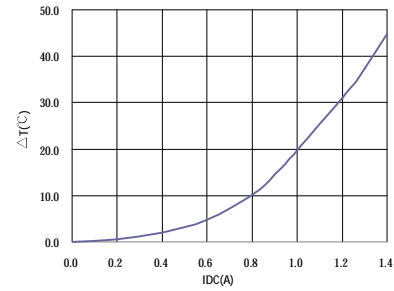
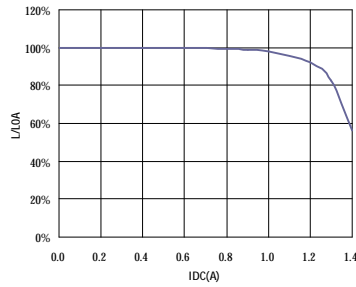

SR0302101KL□

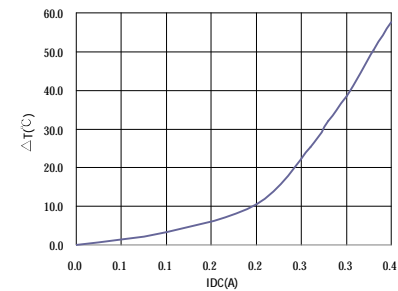
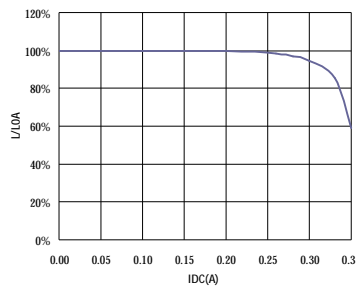

SR0302122KL□

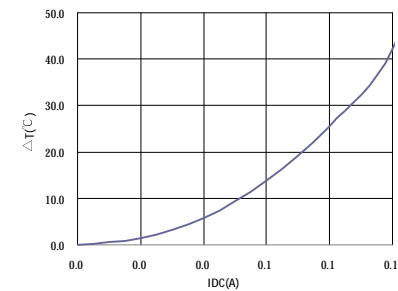
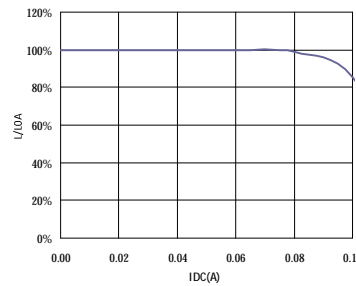

AR-001C

SPECIFICATION FOR APPROVAL

REF. :

PROD. NAME	SMD Power Inductor	ABC'S DWG NO.	SR0302□□□□L□-□□□		
		REV.	20160719-F	PAGE	4

VI . Packaging information :

(1) Configuration

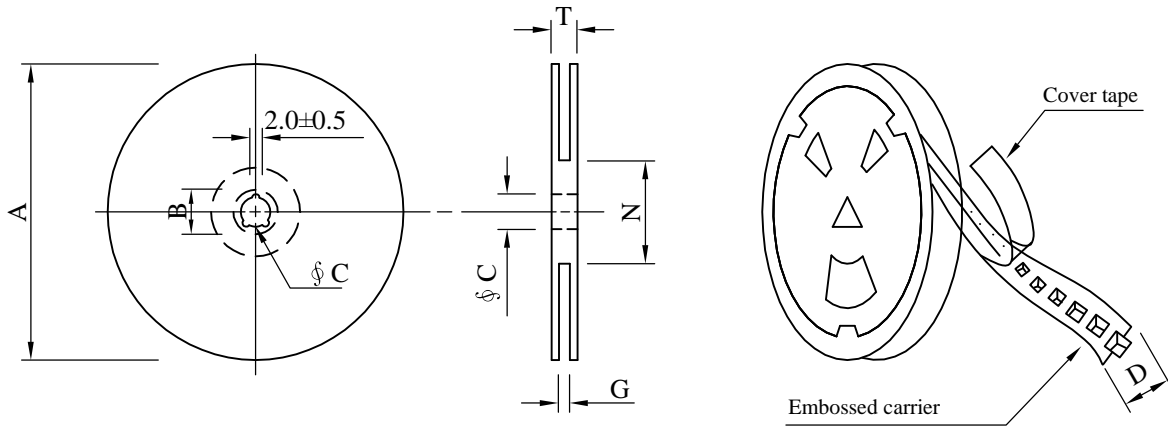

※Carrier tape width : D

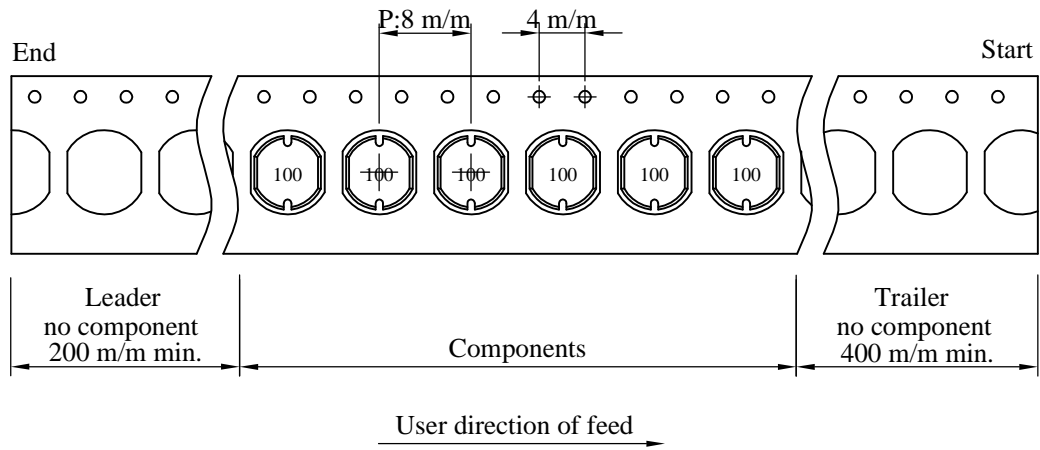

(2) Dimensions

Unit:m/m

Style	A	B	C	D	G	N	T
13 - 12	330	21±0.8	13±0.5	12	14 ⁺⁰	50 ⁻⁰	18.4

(3) Q'TY & G.W. Per package

Code	Inner : Reel			Outer : Carton		
	Q'TY (pcs)	G.W. (gw)	Style	Q'TY (pcs)	G.W. (Kg)	Size (cm)
B	2,000	520	13 - 12	16,000	5.4	38 x 37 x 22
C	1,500	480	13 - 12	12,000	5.1	38 x 37 x 22

AR-001C

SPECIFICATION FOR APPROVAL

REF. :

PROD. NAME	SMD Power Inductor	ABC'S DWG NO.	SR0302□□□□L□-□□□		
		REV.	20160719-F	PAGE	6

VIII . Reliability test :

Item	Reference documents	Test Condition	Test Specification
1.High Temperature Exposure	MIL-STD-202 Method 108	1.Temperature: 125±2℃ 2.Time:96±2 hours.	1.No mechanical or electrical damage. 2.Inductance shall not change more than ±10%.
2.Temperature Cycling	JESD22-A 104	1.Temperature: -40℃ ~ +125℃ 2.Number of cycle:100 cycles. 3.Dwell time:30 minutes	1.No mechanical or electrical damage. 2.Inductance shall not change more than ±10%.
3.Biased Humidity Test	MIL-STD-202 Method 103	1.Temperature : 85±2℃ 2.Humidity: 85% RH. 3.Time:96±2 Hours	1.No mechanical or electrical damage. 2.Inductance shall not change more than ±10%.
4.Operational Life	JESD22-A 108	1.Temperature: 125℃ (Temp. rise included) 2.Time:96±2 hours. 3.Rated current	1.No mechanical or electrical damage. 2.Inductance shall not change more than ±10%.
5.External Visual	JESD22-B 101 & MIL-STD-883 Method 2009	Inspect product constructions, marking and workmanship.	1.No pollution on the surface of products. 2.Clear marking. 3.No crack.
6.Physical Dimensions	JESD22-B 100	Verify physical dimensions to the applicable product detail specification.	Per product specification standard
7.Resistance to solvents	MIL-STD-202 Method 215	Immerse into solvent for 3±0.5 minutes & brush 10 times for 3 cycles.	1.No body change in apperance. 2.No marking blurred. 3.Inductance shall not change more than ±10%.
8.Vibration Test	MIL-STD-202 Method 204	1.Frequency and Amplitud : 10-2000-10 Hz, 1.5 mm. 2.Direction:X, Y, Z 3.Test duration:2 hours for each direction, 6 hours in total.	1.No mechanical or electrical damage. 2.Inductance shall not change more than ±10%.
9.Resistance To Soldering Heat Test	MIL-STD-202 Method 210 & J-STD020D.1	1.Highest temperature : 260±5℃. 2.Time (temp. ≥ 217℃) : 60~150 Seconds. 3.IR reflow times : 3 times.	1.No mechanical or electrical damage. 2.Inductance shall not change more than ±10%.
10.Saturation Current	JIS C 6436 & User SPEC.	1.Applied rated current for 5 seconds. 2.Saturation current	Inductance shall not drop more than 10% typ.
11.Over load	JIS C 6436 & User SPEC.	1.Applied one and half rated current for a period of 5 minutes. 2.Rated current	No electrical or mechanical damage
12.Temperature Rise Current	JIS C 6436 & User SPEC.	1.Applied rated current for 10 minutes. 2.Temperature measure by digital surface thermometer. 3.Irms current	Surface temperature rise is less than 40℃ max.
13.Solderability Test	J-STD-002 & JESD22-B 102	1.Baking in pre-testing : 150±5℃ / 16Hours±30 min. 2.Peak temperature : 240±5℃ 3.Time (temp. ≥ 217℃) : 60~150 seconds. 4.IR reflow times : 1 time.	More than 95% soldering coverage min on terminations.
14.Electrical Characteriazation	MIL-STD-202 Method 304 & User SPEC.	1.Operating temperature : -40℃~125℃ 2.Room temperature : 25℃.	1.No mechanical or electrical damage. 2.Inductance shall not change more than ±10%.
15.Drop	CNS-C6354 & GB/T 2423.8	1.Products shall be mounted on SPEC. pcb and dropped down from a heigh of 1m 2.Drop total time : 6 times. (Every side ofsample drop 2 times)	1. Adhesion on PCB shall be enough. 2. Product appearance shall not break. 3. No electrical damage.
16.Terminal Strength Test	IEC 60068-2-21	1.Apply push force to samples mounted on PCB. 2.Force of 1.8 kg for 60±1 seconds.	After test, inductors shall be no mechanical damage.

AR-001C

