

# SPECIFICATION FOR APPROVAL

REF. :

PROD. NAME	Shielded SMD Power Inductor	ABC'S DWG NO.	SP1235□□□□L□-□□□		
		REV.	20130503-A	PAGE	1

## I . Configuration and dimensions :

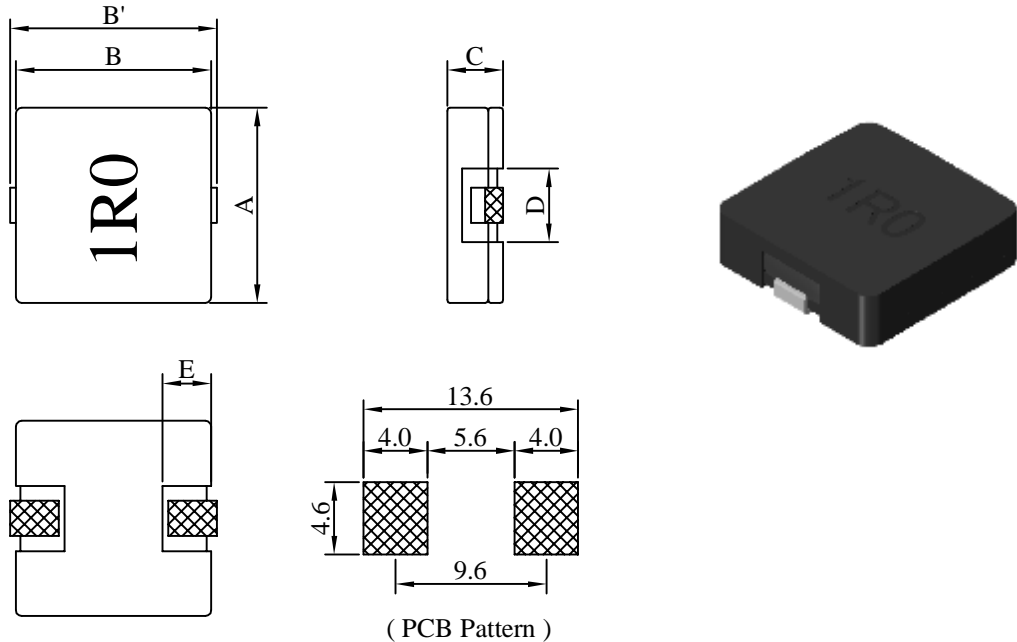

Unit : m/m

A	B	B'	C	D	E
12.70±0.30	12.70±0.30	13.00±0.30	3.50±0.30	4.20 typ.	3.30 typ.

## II . Schematic diagram :

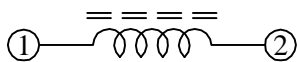

## III . Description :

- a . Ferrite ER core construction.
- b . Magnetically shielded.
- c . Enamelled copper wire : F class
- d . Product weight : 3.10 g ( ref. )
- e . Moisture sensitivity Level 1
- f . Products comply with RoHS' requirements
- g . Halogen free available

## IV . General specification :

- a . Storage temp. : -55°C ~ +125°C
- b . Operating temp. : -55°C ~ +125°C  
( Temp. rise included )
- c . Resistance to solder heat : 245°C . 10 secs.

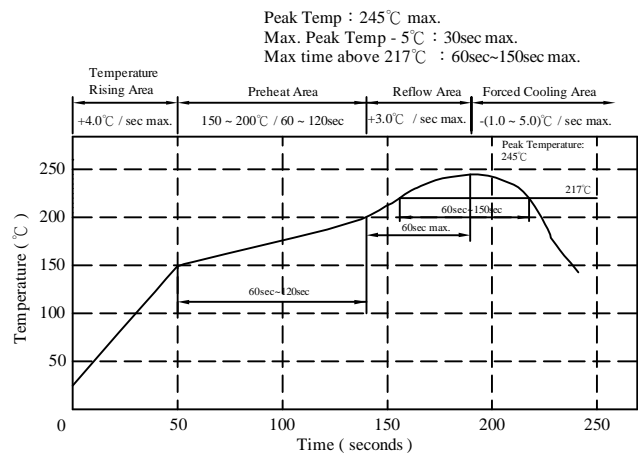

AR-001C

# SPECIFICATION FOR APPROVAL

REF. :

PROD. NAME	Shielded SMD Power Inductor	ABC'S DWG NO.	SP1235□□□□L□-□□□		
		REV.	20130503-A	PAGE	2

V . Electrical characteristics :

DWG No.	Inductance L ( $\mu$ H )	Isat 1 ( A )	Isat 2 ( A )	Irms ( A )	RDC ( $m\Omega$ )	
					max.	typ.
SP1235R22YL□-□□□	$0.22 \pm 30 \%$	35.0	60.0	32.0	1.7	1.3
SP1235R56YL□-□□□	$0.56 \pm 30 \%$	25.0	45.0	22.0	2.6	2.0
SP12351R0YL□-□□□	$1.00 \pm 25 \%$	15.0	30.0	18.6	4.4	3.4
SP12351R8YL□-□□□	$1.80 \pm 25 \%$	12.0	25.0	16.0	5.7	4.4
SP12352R7YL□-□□□	$2.70 \pm 25 \%$	9.0	18.0	14.0	7.4	5.7

- 1). □: Packaging information : □ Code
- 2). "- □□□" : Reference code
- 3). Electrical specifications at 25°C
- 4). Inductance Test Freq. : 100KHz / 1V
- 5). Irms base on Temp. rise 40°C typ.
- 6). Isat 1 base on inductance drop 10% typ. of L value at 20°C
- 7). Isat 2 base on inductance drop 30% typ. of L value at 20°C

AR-001C

# SPECIFICATION FOR APPROVAL

REF. :

PROD. NAME	Shielded SMD Power Inductor	ABC'S DWG NO.	SP1235□□□□L□-□□□		
		REV.	20130503-A	PAGE	3

@ Performance Graphs

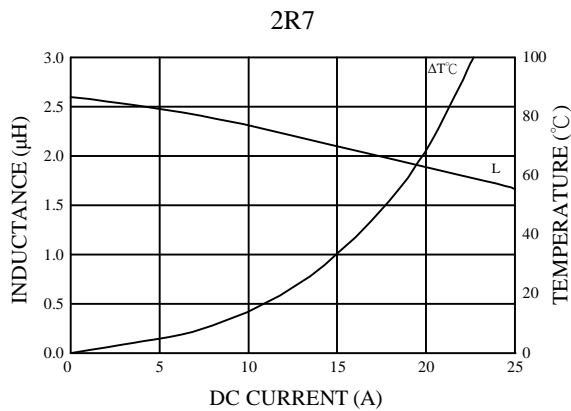
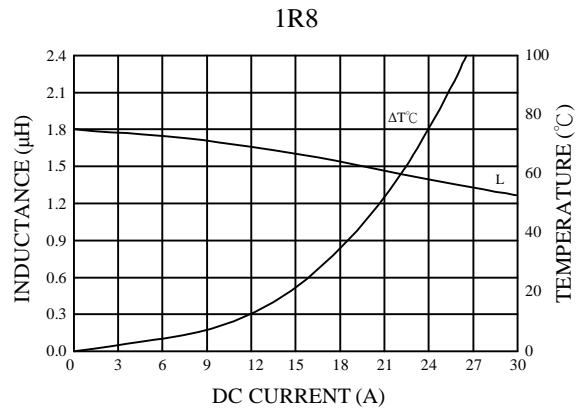
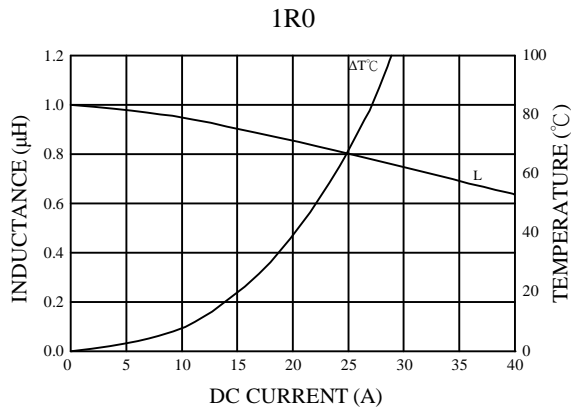
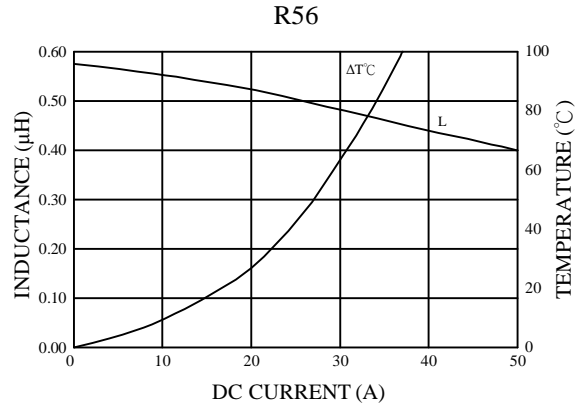
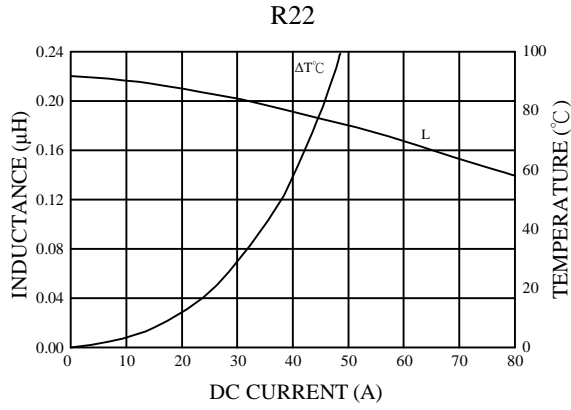

AR-001C

# SPECIFICATION FOR APPROVAL

REF. :

PROD. NAME	Shielded SMD Power Inductor	ABC'S DWG NO.	SP1235□□□□L□-□□□		
		REV.	20130503-A	PAGE	4

## VI . Packaging information :

### ( 1 ) Configuration

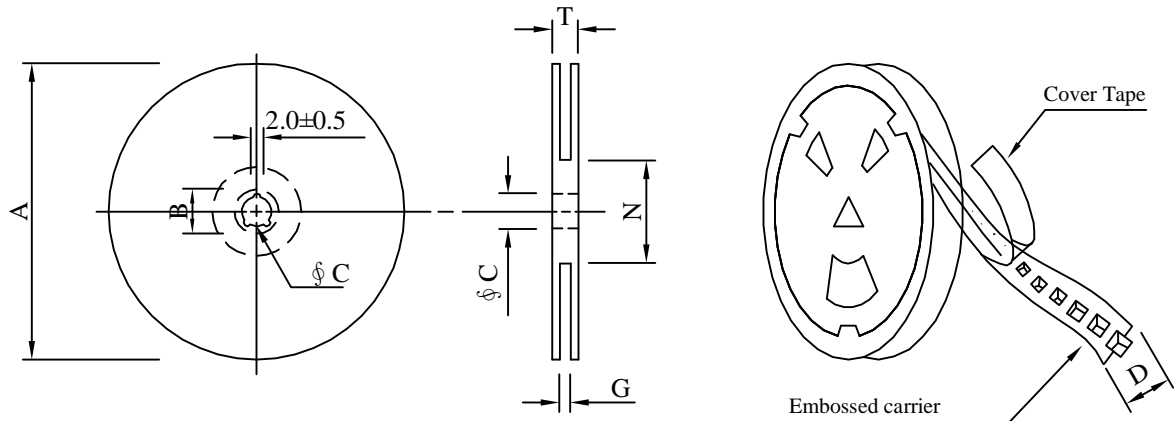

※Carrier tape width : D

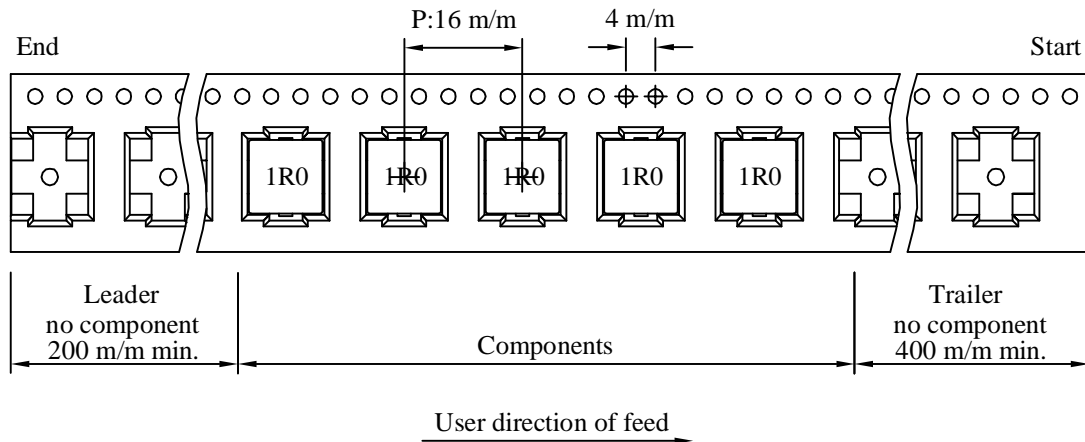

### ( 2 ) Dimensions

Unit:m/m

Style	A	B	C	D	G	N	T
13 - 24	330	21±0.8	13	24	26 <sup>+0</sup>	60 <sup>-0</sup>	30.4

### ( 3 ) Q'TY & G.W. Per package

Code	Inner : Reel			Outer : Carton		
	Q'TY (pcs)	G.W. (gw)	Style	Q'TY (pcs)	G.W. (Kg)	Size (cm)
B	1,000	2,200	13 - 24	4,000	12.0	38 x 37 x 22

AR-001C

# SPECIFICATION FOR APPROVAL

REF. :

PROD. NAME	Shielded SMD Power Inductor	ABC'S DWG NO.	SP1235□□□□L□-□□□		
		REV.	20130503-A	PAGE	5

## VII . Reliability test :

Item	Reference documents	Test Condition	Test Specification
1.High Temperature Exposure	MIL-STD-202 Method 108	1.Temperature: 125℃ 2.Time:96 hours.	1.No mechanical and electrical damage. 2.Inductance shall not change more than ±25%.
2.Temperature Cycling	JESD22 Method JA-104	1.Temperature: -55℃ ~ 125℃ 2.Number of cycle:96 cycle 3.Dwell time:30 minutes	1.No mechanical and electrical damage. 2.Inductance shall not change more than ±25%.
3.Biased Humidity Test	MIL-STD-202 Method 103	1.Temperature: 85±5℃ 2.Time:96 Hours 3.Humidity: 85±5% RH.	1.No mechanical and electrical damage. 2.Inductance shall not change more than ±25%.
4.Operational Life	MIL-PRF-27	1.Temperature: 125℃ 2.Time:96 hours. 3.Apply rated current.	1.No mechanical and electrical damage. 2.Inductance shall not change more than ±25%.
5.Exeternal Visual	MIL-STD-883 Method 2009	Inspect product constructions, marking and workmanship.	1.No pollution on the surface of products. 2.Clear marking. 3.No crack.
6.Physical Dimensions	JESD22 Method JB-100	Verify physical dimensions to the applicable product detail specification.	Per product specification standard
7.Resistance to solvents	MIL-STD-202 Method 215	Immerse into solvent for 3±0.5 minutes & brush 10 times for their cycles.	1.No body change in apperance. 2.No marking blurred. 3.Inductance shall not change more than ±25%.
8.Vibration Test	MIL-STD-202 Method 204	1.Frequency and Amplitued : 10-2000-10 Hz, 1.5 mm. 2.Direction:X, Y, Z 3.Test duration:2 hours for each direction, 6 hours in total.	1.No mechanical and electrical damage. 2.Inductance shall not change more than ±25%.
9.Resistance To Soldering Heat Test	MIL-STD-202 Method 210	1.Highest temperature : 245±5℃ 2.Time ( temp. ≥ 217℃ ) : 60-150 Second. 3.IR reflow times : 3 times.	1.No mechanical and electrical damage. 2.Inductance shall not change more than ±25%.
10.Rated current	MIL-STD-202 Method 330	Apply rated current for 5 second.	1.No mechanical and electrical damage. 2.Inductance shall not change more than ±25%.
11.Temperature rise	MIL-PRF-27	Apply rated current for 10 minutes.	1.No mechanical and electrical damage. 2.Inductance shall not change more than ±25%.
12.Over load	MIL-PRF-27	Apply twice as rated current for 5 minutes. (It's not application to some special design)	1.No mechanical and electrical damage. 2.Inductance shall not change more than ±25%.
13.Solderability Test	J-STD-002	1.Baking in pre-testing : 155±5℃ / 16Hours±30 min. 2.Peak temperature : 240±5℃ 3.Time ( temp. ≥ 217℃ ) : 60~150 second. 4.IR reflow times : 1 times.	The terminal shall be at least 95% covered with fresh solder.
14.Electrical Characteriazation	User Spec.	1.Operating temperature : -55℃~125℃ 2.Room temperature : 25℃.	1.No mechanical and electrical damage. 2.Inductance shall not change more than ±25%.
15.Withstanding Voltage Test	MIL-STD-202 Method 201	1.DV:500V 2.Time:1minutes	1.During the test no breakdown. 2.The characteristic is normal after test.
16.Drop	JESD22-B111	Packaged & Drop down from 1m.In 1 angle 1ridges & 2 surfaces orientation.	1.No case deformation or change in appearance. 2.Inductance shall not change more than ±25%.
17.Terminal Strength Test	JIS-C-6429	1.Apply push force to samples mounted on PCB. 2.Force of 1.8 kg for 60±1 seconds.	After test, inductors shall be no mechanical damage.

AR-001A