



Common Mode Chokes Coil

PWC0603ST Series



INTRODUCTION

This specification is applicable to chip type wire wounded common mode chokes. The PWC series are widely used in USB 2.0, IEEE 1394, LVDS and etc. The wire wound features advance in lower DC resistance and higher current tolerance, and much more stable performance.

FEATURES

- Operating temperature -40 to +85°C.
- Excellent solderability and resistance to soldering heat.
- Suitable for reflow soldering.
- Good dimensions, high reliability and easy surface mount assembly.

PART NUMBER

PWC 0603 S T 900 S - □□

1 2 3 taping 4 5 6

1 Product Type

2 Chip Dimension

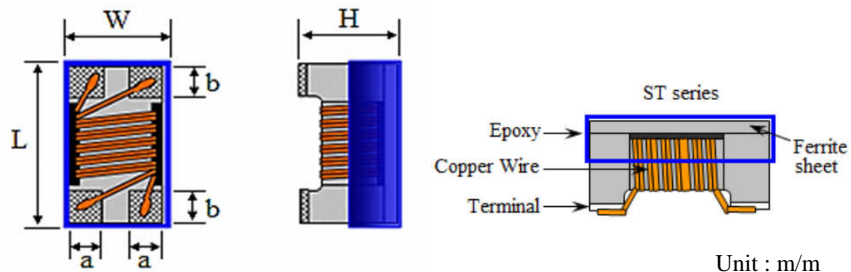

Unit : m/m

Size	Length (L)	Width (W)	Thickness (H)	Terminal (a)	Terminal (b)
0603ST	1.60 ± 0.10	0.85 ± 0.10	1.10 ± 0.10	0.25 ref.	0.33 ref.

3 Coating Type S : Coating with Ferrite sheet

4 Impedance Value 900 = 90Ω 181 = 180Ω

5 Tolerance S = ±25%

6 Internal Code

1 Scope

This specification applies to wire wound chip common mode choke of the following types used in electronic equipment:

*Material : Ferrite

2 Construction

*Configuration

& Dimension : Please refer to the attached figures and tables.

*Terminals : Consist of Ag alloy followed by Nickel, then Sn or Au plating.

3 Operating Temperature Range

Operating Temperature Range is the scope of ambient temperature at which the common mode choke can be operated continuously at rated current.

*Temp. Range : $-40^{\circ}\text{C} \sim +85^{\circ}\text{C}$

4 Recommended Soldering Conditions

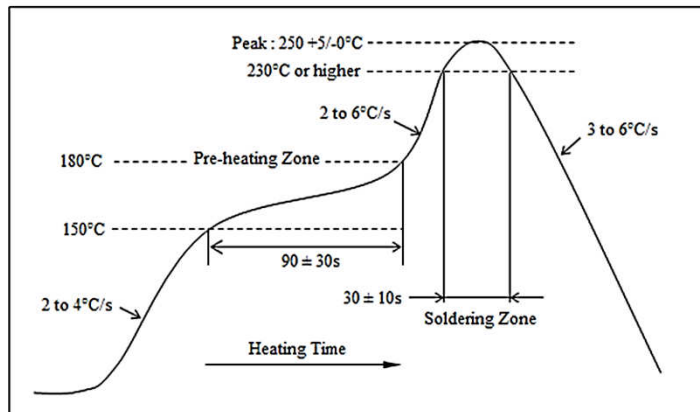

5 Characteristics

Standard Atmospheric Conditions

Unless otherwise specified, the standard range of atmospheric conditions for making measurements and tests are as follows:

Ambient Temperature : $25^{\circ}\text{C} \pm 2^{\circ}\text{C}$

Relative Humidity : 60% to 70%

Air Pressure : 86Kpa to 106Kpa

PWC0603ST Series

Part No.	Impedance ¹ (Ω)	Rated Voltage V (DC)	Withstanding Voltage V (DC)	Rated ² Current Max (mA)	DC Resistance Max (Ω)	Insulation Resistance Min (MΩ)
PWC0603ST 220S -□□	22 @ 100MHz	50	125	500	0.080	10
PWC0603ST 450S -□□	45 @ 100MHz	50	125	500	0.110	10
PWC0603ST 900S -□□	90 @ 100MHz	50	125	500	0.145	10
PWC0603ST 121S -□□	120 @ 100MHz	50	125	500	0.175	10
PWC0603ST 181S -□□	180 @ 100MHz	50	125	500	0.210	10
PWC0603ST 251S -□□	250 @ 100MHz	50	125	400	0.280	10

1. Impedance is measured in HP4287A (or equivalent) at frequency of 100MHz.
2. For 15 °C Rise.

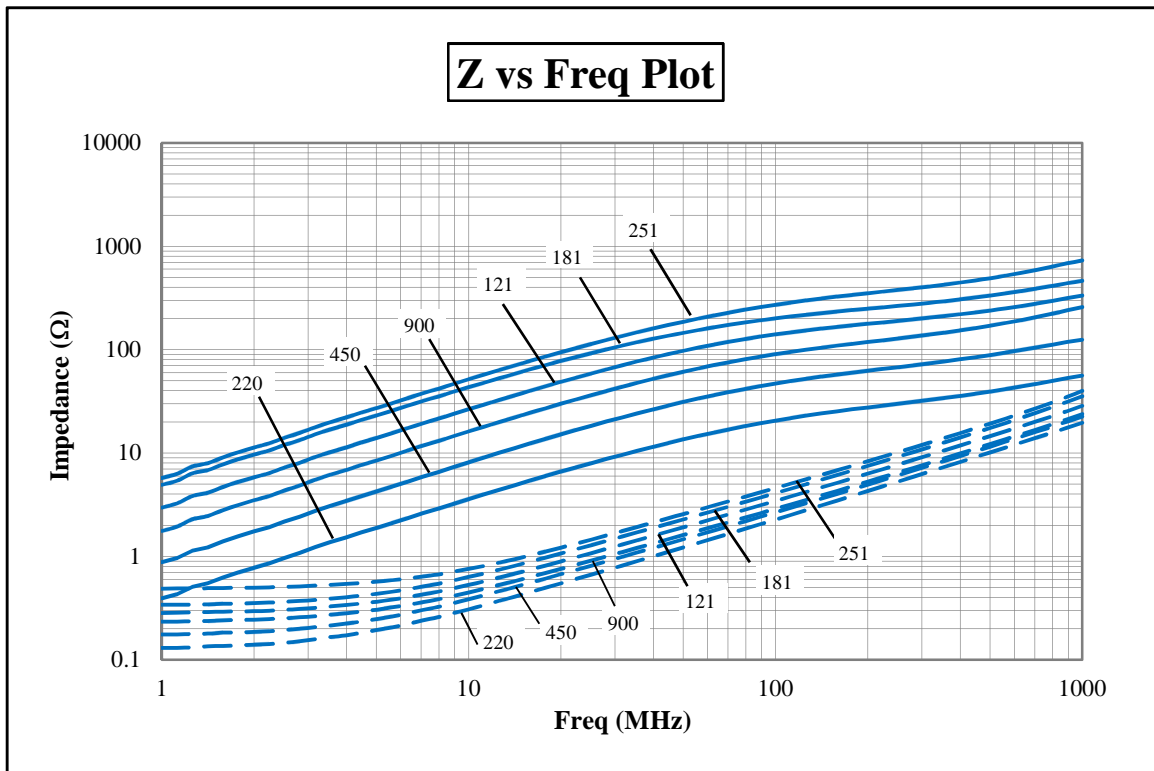

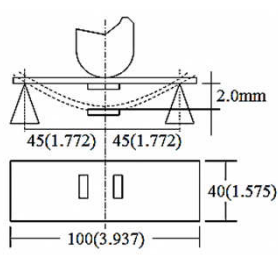
ITEM		CONDITION	SPECIFICATION
Electrical Characteristics	Common Mode Impedance (Z_c) and Tolerance	Measuring Equipment : HP-4287A or equivalent Measuring Frequency : 100 ± 1 MHz Measuring Temperature : $25 \pm 5^\circ\text{C}$ (Refer to Measurement Diagram)	Within $\pm 25\%$
	Insulation Resistance	Measuring Voltage : Rated Voltage Measuring Time : 1 minute max. (Refer to Measurement Diagram)	10M Ω minimum
	Dielectric Withstanding Voltage	Test Voltage : 2.5 times to Rated Voltage Time : 1 to 5 seconds Charge current : 1mA max. (Refer to Measurement Diagram)	No damage occurs when the test voltage is applied.
	Rated Current	Test Current : Rated Current (Refer to Measurement Diagram)	Temperature Rise : $\leq 15^\circ\text{C}$
	DC Resistance (RDC)	Measured with current of 100mA max. In case of doubt, measured by four terminal method. (Refer to Measurement Diagram)	Within Specified Tolerance.
Mechanical Characteristics	Flexure Strength		Change in Appearance : Without distinct damage Change in Common Mode Impedance : Within $\pm 20\%$ Insulation Resistance : 10M Ω min.
	Drop Test	Components shall be dropped 3 times on a concrete or steel board at height of 1 M naturally at any directions.	Withstanding Voltage : No damaged
	Vibration (Random)	Components shall be randomly vibrated at amplitude of 1.5mm and frequency of 10-55Hz : 0.04G/Hz, 1 minute at a period of 2 hours in each of the 3 mutually perpendicular directions.	
	Resistance to Soldering Heat	Preheat components at 80 to 120°C for 1 minute. Dip components into flux and then into a melted solder bath at $260 \pm 5^\circ\text{C}$ for 5 ± 1 seconds. Then components are to be tested after 4-48 hours at room temperature.	
	Solderability	Dip pads in flux and then in a solder bath at $240 \pm 5^\circ\text{C}$ for 5 seconds.	A minimum of 80% of the metalized area must be covered with new solder
	Component Adhesion (Push Test)	Components shall be reflow solder onto a PC board ($240 \pm 5^\circ\text{C}$ for 20 seconds). Then a dynamometer force gauge shall be applied to any side of the components	0603 : 0.5Kg minimum 0805 : 1.0Kg minimum 1206 : 1.0Kg minimum Without failure of termination to the component attachment.



ITEM		CONDITION	SPECIFICATION
Endurance Characteristics	Cold Temperature Storage	Components shall be stored at temperature of $-40\pm 2^{\circ}\text{C}$ for 1000 (+48 hours -0 hour). Then components shall be subjected to standard atmospheric conditions for 4-48 hours. After that measurement shall be made.	Change in Appearance : Without distinct damage Change in Common Mode Impedance : Within $\pm 20\%$
	High Temperature Storage	Components shall be stored at temperature of $+85\pm 2^{\circ}\text{C}$ for 1000 (+48 hours -0 hour). Then components shall be subjected to standard atmospheric conditions for 4-48 hours. After that measurement shall be made.	Insulation Resistance : 10M Ω min. Withstanding Voltage : No damaged
	Moisture Resistance	Components shall be stored in the chamber at 40°C at 90-95% R.H. for 1000 (+48 hours -0 hour). Then components are to be tested after 4-48 hours at room temperature.	
	Temperature Cycle	Each cycle shall consist of 30 minutes at -40°C followed by 30 minutes at 85°C with a 10-15 minutes maximum transition time between temperature extremes. Test duration is 100 cycles, then components are to be tested after 4-48 hours at room temperature.	
	High Temperature with Loaded (Rated Current)	Components shall be stored at temperature of $+85\pm 2^{\circ}\text{C}$ for 1000 (+48 hours -0 hour) with rated current applied. Then components shall be subjected to standard atmospheric conditions for 4-48 hours. After that measurement shall be made.	

Measurement Diagram

Terminal to be Tested

When measuring and supplying the voltage, the following terminal is applied.

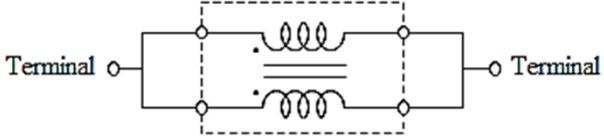
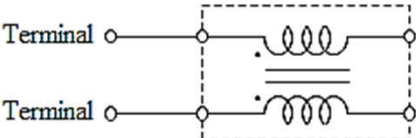
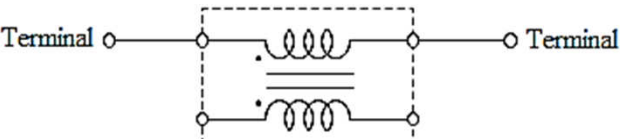
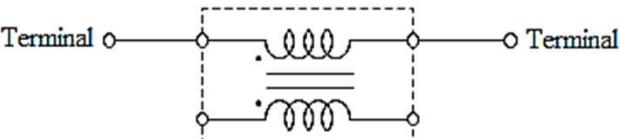
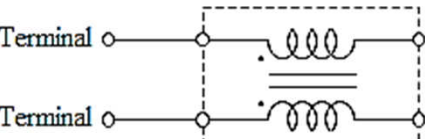
No.	Item	Terminal to be tested
1	Common Mode Impedance (Measurement Terminal)	
2	Withstanding Voltage (Measurement Terminal)	
3	DC Resistance (Measurement Terminal)	
4	Rated Current	
5	Insulation Resistance	

Type	Pcs/Reel
PWC0603	2,000

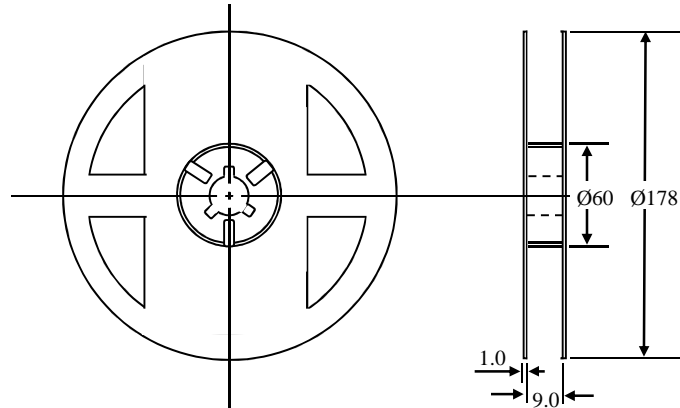

Type	Chip Cavity		Insert Pitch	Tape Thickness		
	A	B		K	T	W
PWC0603	1.05	1.85	4.00	1.15	0.23	8.00

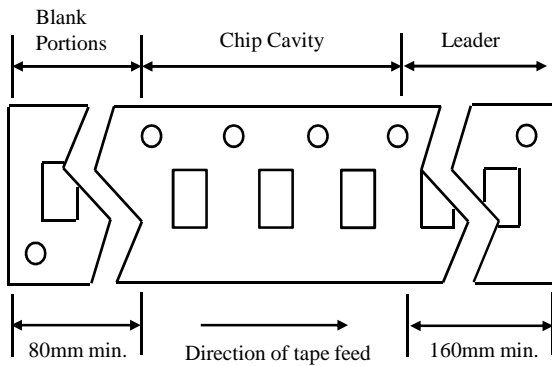
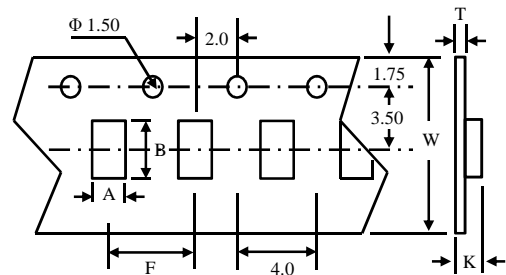

Top Tape Strength

The top tape requires a peel-off force of 0.2 to 0.7N in the direction of the arrow as illustrated below.

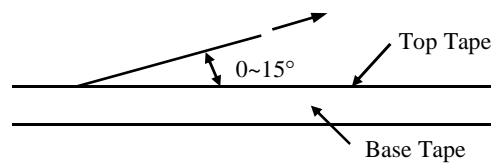

Dimensions (unit : m/m)

Type	A	B	C	D
PWC0603	0.25	0.85	0.60	0.25

Recommended Pattern

