

Halter/Reflektor Kombination
Holder/Reflector combination



**LENA
 LENINA**

Ledil Adapter
Ledil adaptor [C13868 Lena-STD-Base-VERO 13-18](#)
[C13867 Lena-STD-Base-VERO 29](#)

Hersteller Webseite
Manufactures website www.ledil.com

LED Halter Bender + Wirth
LED Holder Bender + Wirth
 4xx / Typ L1
 4xx / Typ L2
 4xx / Typ L3

Zertifizierung
Certificates

40041342
 E472943

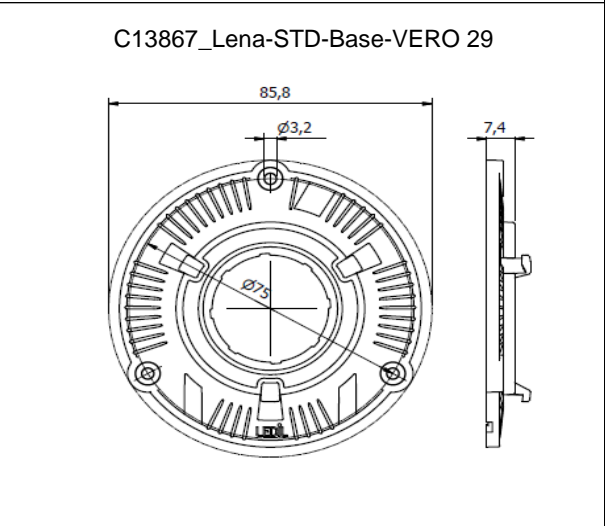
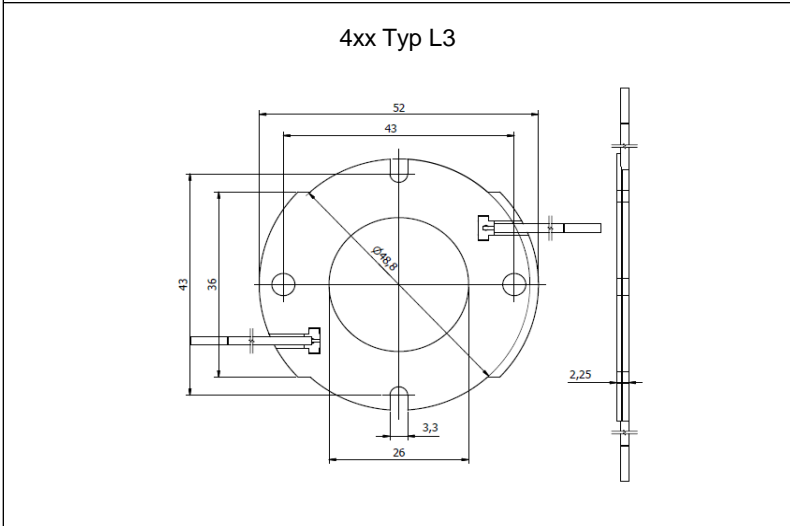
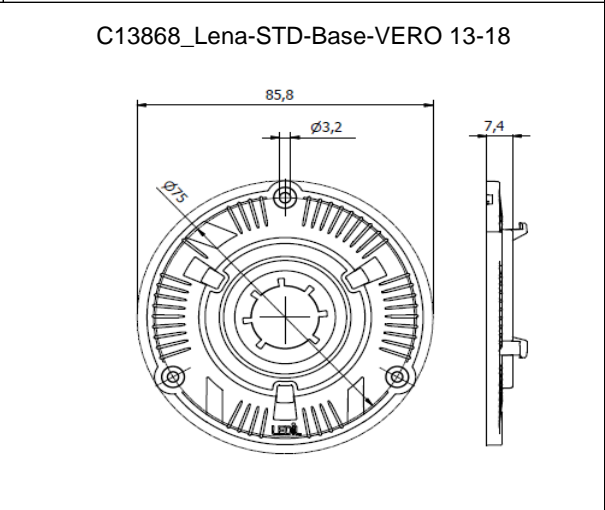
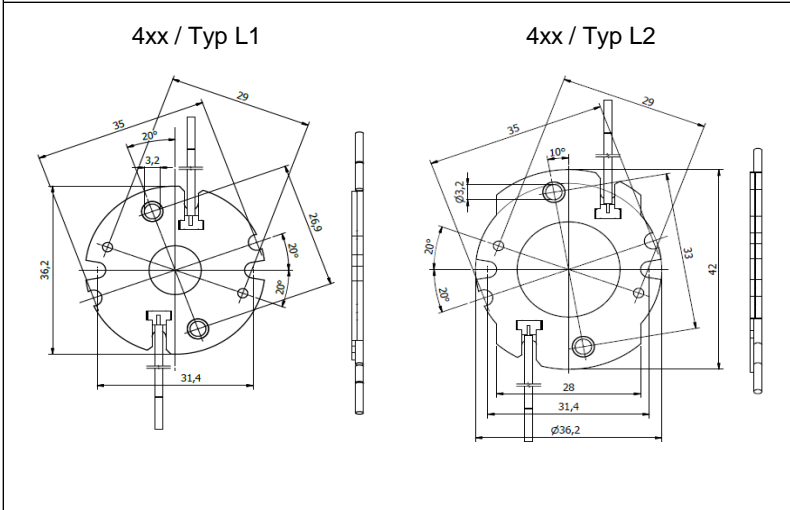
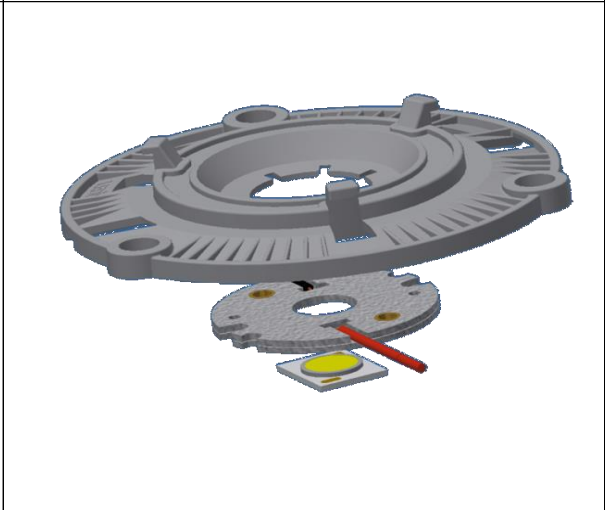



Mögliche Halter / COB Kombinationen / Holder / COB combination



	Halter holder	BENDER +WIRTH	Adapter adaptor	
V10	455 Typ L1		C13868_Lena-STD-Base-VERO 13-18	
V13	455 Typ L1		C13868_Lena-STD-Base-VERO 13-18	
V15	456 Typ L1		C13868_Lena-STD-Base-VERO 13-18	
V18	456 Typ L1		C13868_Lena-STD-Base-VERO 13-18	
V22	431 Typ L3		C13867_Lena-STD-Base-VERO 29	



	Halter holder	BENDER +WIRTH	Adapter adaptor	
CLL 022	434 Typ L1		C13868_Lena-STD-Base-VERO 13-18	
CLL 032	433 Typ L1		C13868_Lena-STD-Base-VERO 13-18	
CLL 042	431 Typ L3		C13867_Lena-STD-Base-VERO 29	
CLU 024 / 026 / 028	434 Typ L1		C13868_Lena-STD-Base-VERO 13-18	
CLU 025 / 027	434 Typ L1		C13868_Lena-STD-Base-VERO 13-18	
CLU 034 / 036 / 038	433 Typ L1		C13868_Lena-STD-Base-VERO 13-18	
CLU 044 / 046 / 048	431 Typ L3		C13867_Lena-STD-Base-VERO 29	
CLU 710 / 711	470 Typ L1		C13868_Lena-STD-Base-VERO 13-18	
CLU 720 / 721	433 Typ L1		C13868_Lena-STD-Base-VERO 13-18	
CLU 730 / 731	471 Typ L3		C13867_Lena-STD-Base-VERO 29	



	Halter holder	BENDER +WIRTH	Adapter adaptor	
CXA/B 1816	437 Typ L1		C13868_Lena-STD-Base-VERO 13-18	
CXA/B 1820	437 Typ L1		C13868_Lena-STD-Base-VERO 13-18	
CXA/B 1830	457 Typ L1		C13868_Lena-STD-Base-VERO 13-18	
CXA 1850	437 Typ L1		C13868_Lena-STD-Base-VERO 13-18	
CXA 2520	439 Typ L3		C13867_Lena-STD-Base-VERO 29	
CXA/B 2530	439 Typ L3		C13867_Lena-STD-Base-VERO 29	
CXA/B 2540	439 Typ L3		C13867_Lena-STD-Base-VERO 29	
CXA 2590	439 Typ L3		C13867_Lena-STD-Base-VERO 29	
CXA/B 3050	447 Typ L3		C13867_Lena-STD-Base-VERO 29	
CXA/B 3070	447 Typ L3		C13867_Lena-STD-Base-VERO 29	



	Halter holder	BENDER +WIRTH	Adapter adaptor	
HM 16 / 24 / 30	433 Typ L1		C13868_Lena-STD-Base-VERO 13-18	
HM 40	431 Typ L3		C13867_Lena-STD-Base-VERO 29	



	Halter holder BENDER +WIRTH	Adapter adaptor 
XUAN 1313	434 Typ L1	C13868_Lena-STD-Base-VERO 13-18
XUAN 1919	433 Typ L1	C13868_Lena-STD-Base-VERO 13-18
CHI 2024	469 Typ L3	C13867_Lena-STD-Base-VERO 29
CHI 3030	468 Typ L3	C13867_Lena-STD-Base-VERO 29



	Halter holder BENDER +WIRTH	Adapter adaptor 
PB15H04 / PB15H05 / PB15U06	437 Typ L1	C13868_Lena-STD-Base-VERO 13-18
PB20H03	437 Typ L1	C13868_Lena-STD-Base-VERO 13-18
PB30H04	437 Typ L1	C13868_Lena-STD-Base-VERO 13-18
PB20H01 / PB20U02	431 Typ L3	C13867_Lena-STD-Base-VERO 29
PB30H02 / PB30U03	431 Typ L3	C13867_Lena-STD-Base-VERO 29
PB40H02 / PB40U03	431 Typ L3	C13867_Lena-STD-Base-VERO 29



	Halter holder BENDER +WIRTH	Adapter adaptor 
24W COB (LEMWM18)	445 Typ L2	C13868_Lena-STD-Base-VERO 13-18
40W COB (LEMWM28)	431 Typ L3	C13867_Lena-STD-Base-VERO 29



	Halter holder BENDER +WIRTH	Adapter adaptor 
Luxeon CoB 1204 / 1205	432 Typ L2	C13868_Lena-STD-Base-VERO 13-18
Luxeon CoB 1208	432 Typ L2	C13868_Lena-STD-Base-VERO 13-18
Luxeon CoB 1211	431 Typ L3	C13867_Lena-STD-Base-VERO 29
Luxeon CoB 1216	431 Typ L3	C13867_Lena-STD-Base-VERO 29



	Halter holder BENDER +WIRTH	Adapter adaptor 
CHM / CLM / CXM-14 (AC00)	433 Typ L1	C13868_Lena-STD-Base-VERO 13-18
CHM-9 (XH00)	433 Typ L1	C13868_Lena-STD-Base-VERO 13-18
CHM-11 (XH00)	433 Typ L1	C13868_Lena-STD-Base-VERO 13-18
CHM / CVM / CXM-18	453 Typ L2	C13868_Lena-STD-Base-VERO 13-18
CHM-14 (XH00)	453 Typ L2	C13868_Lena-STD-Base-VERO 13-18
CHM / CXM-22 (AC00)	431 Typ L3	C13867_Lena-STD-Base-VERO 29
CHM / CVM / CXM-27	454 Typ L3	C13867_Lena-STD-Base-VERO 29



	Halter holder BENDER +WIRTH	Adapter adaptor 
NV.. 024Z	438 Typ L1	C13868_Lena-STD-Base-VERO 13-18
NF.. 036B	438 Typ L1	C13868_Lena-STD-Base-VERO 13-18
NF.. 060B	438 Typ L1	C13868_Lena-STD-Base-VERO 13-18
NV.. 048Z	463 Typ L2	C13868_Lena-STD-Base-VERO 13-18
NF.. 108B	463 Typ L2	C13868_Lena-STD-Base-VERO 13-18
NF.. 130B	463 Typ L2	C13868_Lena-STD-Base-VERO 13-18



	Halter holder BENDER +WIRTH	Adapter adaptor 
Soleriq S13	437 Typ L1	C13868_Lena-STD-Base-VERO 13-18
Soleriq S13 2nd Gen.	477 Typ L1	C13868_Lena-STD-Base-VERO 13-18
Soleriq S19	462 Typ L3	C13867_Lena-STD-Base-VERO 29



	Halter holder BENDER +WIRTH	Adapter adaptor 
CoB PACE	434 Typ L1	C13868_Lena-STD-Base-VERO 13-18
CoB PACF	433 Typ L1	C13868_Lena-STD-Base-VERO 13-18
CoB PACG	431 Typ L3	C13867_Lena-STD-Base-VERO 29

	Halter holder BENDER +WIRTH	Adapter adaptor 
LC013B	451 Typ L1	C13868_Lena-STD-Base-VERO 13-18
LC019B	465 Typ L1	C13868_Lena-STD-Base-VERO 13-18
LC026B / LC033B / LC040B	450 Typ L2	C13868_Lena-STD-Base-VERO 13-18
LC040C	480 Typ L1	C13868_Lena-STD-Base-VERO 13-18

	Halter holder BENDER +WIRTH	Adapter adaptor 
ZC12 / ZC18	433 Typ L1	C13868_Lena-STD-Base-VERO 13-18
ZC25 / ZC40 / ZC60	431 Typ L3	C13867_Lena-STD-Base-VERO 29

	Halter holder BENDER +WIRTH	Adapter adaptor 
Mega Zenigata	432 Typ L2	C13868_Lena-STD-Base-VERO 13-18
Tiger Zenigata	442 Typ L3	C13867_Lena-STD-Base-VERO 29

 enlightening your ideas	Halter holder 	Adapter adaptor 
SLE G5 LES 11	434 Typ L1	C13868_Lena-STD-Base-VERO 13-18
SLE G5 LES 15	433 Typ L1	C13868_Lena-STD-Base-VERO 13-18
SLE G5 LES 17	467 Typ L2	C13868_Lena-STD-Base-VERO 13-18
SLE G5 LES 19	466 Typ L3	C13867_Lena-STD-Base-VERO 29
SLE G5 LES 23	466 Typ L3	C13867_Lena-STD-Base-VERO 29

	Halter holder 	Adapter adaptor 
DMC 124 / 125	433 Typ L1	C13868_Lena-STD-Base-VERO 13-18
DMC 128	433 Typ L1	C13868_Lena-STD-Base-VERO 13-18
DMC 12C / 18C	431 Typ L3	C13867_Lena-STD-Base-VERO 29
DMS 099	433 Typ L1	C13868_Lena-STD-Base-VERO 13-18
DMS 120	431 Typ L3	C13867_Lena-STD-Base-VERO 29
DMS 150	431 Typ L3	C13867_Lena-STD-Base-VERO 29

Ist Ihre COB oder die gewünschte Bauform nicht aufgeführt? Bitte sprechen Sie uns an.
If your COB or requested shape is not available, please contact us.

Die Informationen in diesem Dokument sind ohne Gewähr und können ohne Vorankündigung geändert werden.
The information in this document is provided without liability and subject to change without notice.

Die dargestellten Halter / Reflektor Kombinationen zeigen lediglich die technische Machbarkeit.
Die Kabelaustritte an den Haltern sind abhängig vom verwendeten COB.
Optische Daten und Datenblätter gibt es auf Anfrage nach Verfügbarkeit beim Reflektorhersteller.
The represented holder / reflector combinations show only the technical feasibility.
The cable exits of the holders are pending on the COB.
Optical data and datasheets are available on request and availability at the reflector manufacturer.