

Wide input voltage , non-isolated & regulated single output

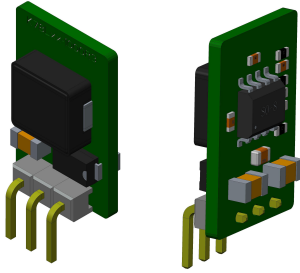

FEATURES

- High efficiency up to 96%
- No-load input current as low as 0.1mA
- Operating temperature range: -40°C to +85°C
- Support the negative output
- Output short circuit protection
- Pin-out compatible with LM78XX linear regulators
- IEC60950, UL60950, EN60950 approval

cULus CB CE Patent Protection RoHS



K78Lxx-1000R3 series are high efficiency switching regulators and ideal substitutes of LM78xx series three-terminal linear regulators. The product is featured with high efficiency, low loss and no heat sink requirement. They are widely used in industrial control, instrumentation, and electric power applications.

Selection Guide

Certification	Part Number	Input Voltage (VDC)	Output		Efficiency (%/Typ.) (Min. Vin)/ (Max. Vin) @Full Load	Max. Capacitive Load(μF)
		Nominal (Range)	Output Voltage (VDC)	Max. Output Current (mA)		
UL/CE/CB	K78L03-1000R3	24 (6-36)	3.3	1000	90/81	680
	K78L05-1000R3	24 (8-36)	5	1000	93/86	680
		12 (8-27)	-5	-500	86/82	330
	K78L12-1000R3	24 (16-36)	12	1000	96/93	680
		12 (8-20)	-12	-300	89/88	330
	K78L15-1000R3	24 (20-36)	15	1000	96/94	680
12 (8-18)		-15	-300	89/89	330	

Note:For input voltage higher than 30 VDC, a 22μF/50V input capacitor is required.

Input Specifications

Item	Operating Conditions	Min.	Typ.	Max.	Unit
No-load Input Current	Positive output	--	0.1	1	mA
Reverse Polarity Input		Forbidden			
Input Filter		Capacitor filter			

Output Specifications

Item	Operating Conditions	Min.	Typ.	Max.	Unit	
Output Voltage Accuracy	Full load, input voltage range	K78L03-1000R3	--	±2	±4	%
		Others	--	±2	±3	
Line Regulation	Full load, input voltage range	--	±0.2	±0.4	%	
Load Regulation	Nominal input, 10% -100% load	--	±0.4	±0.6		
Ripple & Noise*	20MHz bandwidth, nominal input, 20% -100% load	--	20	75	mVp-p	
Temperature Drift Coefficient	Operating temperature -40°C ~ +85°C	--	--	±0.03	%/°C	
Transient response deviation	Nominal input,	--	50	300	mV	
Transient recovery time	25%-50%-25%, 50%-75%-50% load step change	--	0.1	1	ms	
Output short circuit protection	Nominal input	Continuous, self-recovery				

Note: *1. Ripple and noise tested with "parallel cable" method, please refer to DC-DC Converter Application Notes for specific operation methods;

*2. With the load lower than 20%, the maximum ripple and noise of 3.3V/5V output products will be 100mVp-p, 12V/15V output products will be 2%Vo.

General Specifications

Item	Operating Conditions	Min.	Typ.	Max.	Unit	
Operating Temperature	Derating if the temperature $\geq 71^{\circ}\text{C}$ (see Fig. 1)	-40	--	85	°C	
Storage Temperature		-55	--	125		
Pin Welding Resistance Temperature	Welding time: 10s (Max.)	--	--	260		
Storage Humidity	Non-condensing	5	--	95	%RH	
Switching Frequency	Full load, nominal input	K78L03-1000R3/K78L05-1000R3	420	520	620	KHz
		Others	580	680	780	
MTBF	MIL-HDBK-217F@25°C	2000	--	--	K hours	

Physical Specifications

Package Dimensions	11.50mm*7.50mm*17.50 mm
Weight	2.1g (Typ.)
Cooling Method	Free air convection

EMC Specifications

EMI	CE	CISPR22/EN55022	CLASS B (see Fig. 4-② for recommended circuit)	
	RE	CISPR22/EN55022	CLASS B (see Fig. 4-② for recommended circuit)	
EMS	ESD	IEC/EN 61000-4-2	Contact $\pm 4\text{KV}$	perf. Criteria B
	RS	IEC/EN 61000-4-3	10V/m	perf. Criteria A
	EFT	IEC/EN 61000-4-4	$\pm 1\text{KV}$ (see Fig. 4-① for recommended circuit)	perf. Criteria B
	Surge	IEC/EN 61000-4-5	line to line $\pm 1\text{KV}$ (see Fig. 4-① for recommended circuit)	perf. Criteria B
	CS	IEC/EN 61000-4-6	3Vr.m.s	perf. Criteria A

Product Characteristic Curve

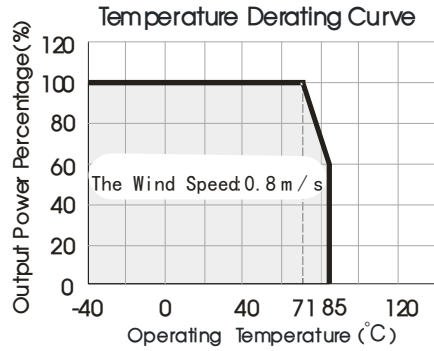
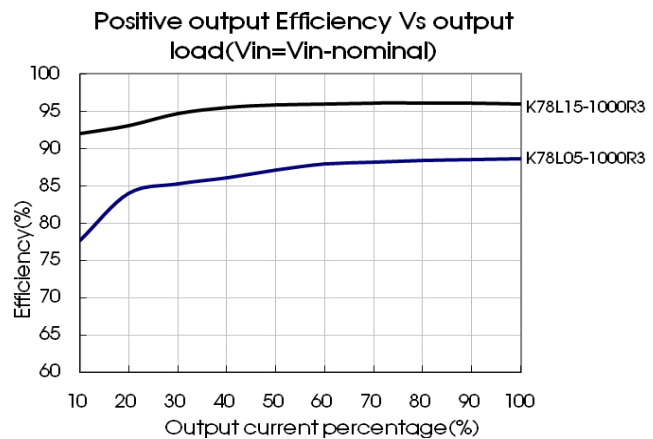
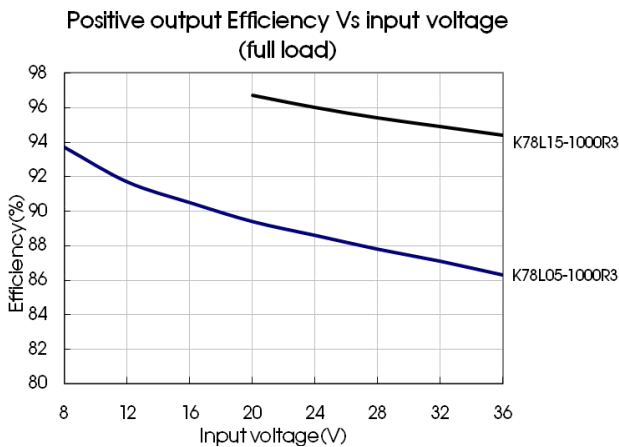
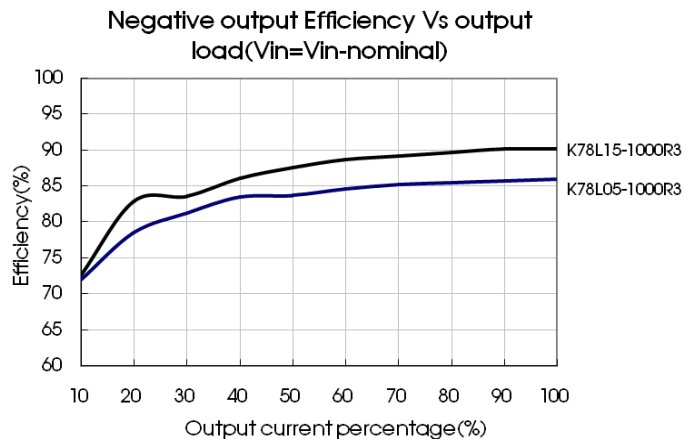
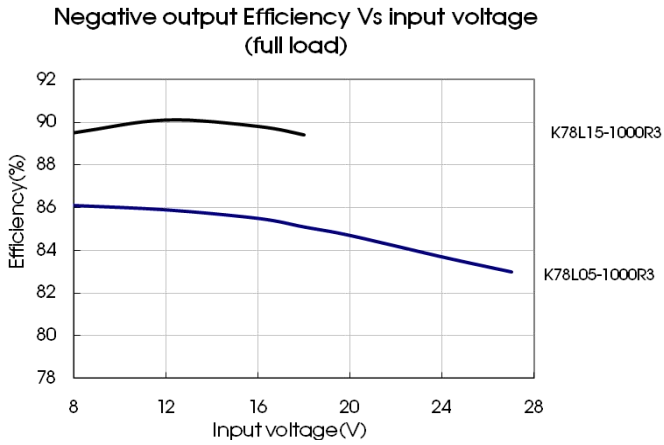

Fig. 1





Design Reference

1. Typical application circuit

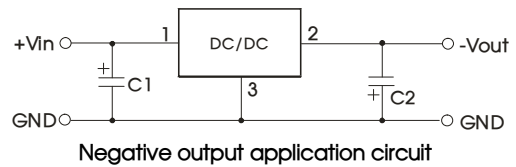
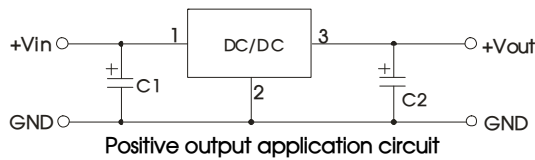

Fig. 2 Typical application circuit

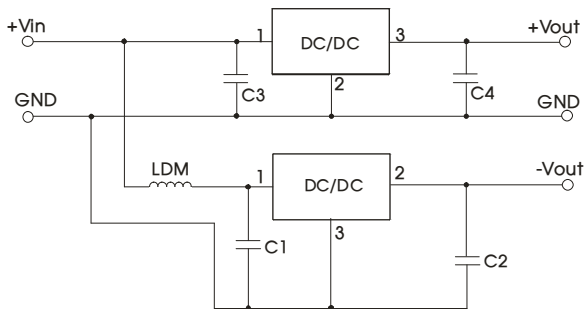

Fig. 3 Positive and Negative output parallelling application circuit

Sheet 1

Part No.	C1/C3 (ceramic capacitor)	C2/C4 (ceramic capacitor)
K78L03-1000R3	10μF/50V	22μF/10V
K78L05-1000R3		22μF/10V
K78L12-1000R3		22μF/25V
K78L15-1000R3		22μF/25V

- Note:
- C1 and C2 (C3 and C4) are required and should be connected close to the pin terminal of the module.
 - The capacitance of C1 and C2 (C3 and C4) refer to Sheet 1.
 - To reduce the output ripple furtherly, C2 and C4 can be increased properly if required, tantalum capacitor and aluminum electrolytic capacitor of low ESR may also suffice.
 - When the products used as the circuit like figure 3, an inductor named as LDM up to 10μH is recommended in the circuit to reduce the mutual interference.
 - Cannot be used in parallel to enlarge the power for output and hot swap.

2. EMC solution-recommended circuit

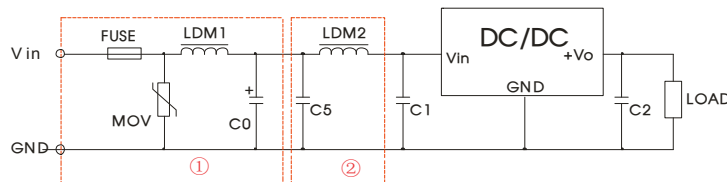

Fig.4 EMC recommended circuit

FUSE	MOV	LDM1	C0	C1/C2	C5	LDM2
Selected based on the actual input current from the customer	S20K30	82μH	680μF /50V	Refer to Sheet 1	4.7μF /50V	12μH

Note: Part ① in the Fig. 4 is for EMS test, part ② is for EMI filtering; parts ① and ② can be added based on actual requirement.

3. For more information please find the application notes on www.mornsun-power.com

Dimensions and Recommended Layout

THIRD ANGLE PROJECTION 

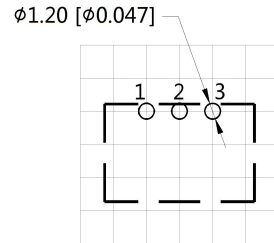
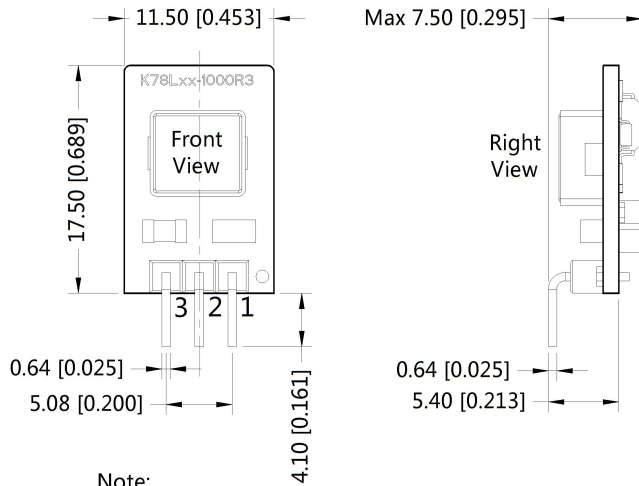

Note : Grid 2.54*2.54mm

Note:
 Unit :mm[inch]
 Pin section tolerances : $\pm 0.10[\pm 0.004]$
 General tolerances: $\pm 0.50[\pm 0.020]$

Pin-Out		
Pin	Positive Output	Negative Output
1	Vin	Vin
2	GND	-Vo
3	+Vo	GND

Notes:

1. Packing information please refer to Product Packing Information which can be downloaded from www.mornsun-power.com. Packing bag number: 58010116;
2. The maximum capacitive load offered were tested at input voltage range and full load;
3. Unless otherwise specified, parameters in this datasheet were measured under the conditions of $T_a=25^\circ\text{C}$, humidity<75% with nominal input voltage and rated output load;
4. All index testing methods in this datasheet are based on our Company's corporate standards;
5. We can provide product customization service, please contact our technicians directly for specific information;
6. Specifications are subject to change without prior notice.

MORNSUN Guangzhou Science & Technology Co., Ltd.

Address: No. 5, Kehui St. 1, Kehui Development Center, Science Ave., Guangzhou Science City, Luogang District, Guangzhou, P. R. China
 Tel: 86-20-38601850-8801 Fax: 86-20-38601272 E-mail: info@mornsun.cn