

Features

1. Current transfer ratio
(CTR:MIN.60% at $I_F = \pm 1\text{mA}$ $V_{CE} = 5\text{V}$)
2. High isolation voltage between input and output
(Viso:5000Vrms).
3. Compact dual-in-line package.
4. Ac input.
5. Available package : DIP/ SMD/ H.

Applications

1. Programmable Controller Applications for Low Input Photocouplers and High Vceo Photocouplers.
2. Telephone sets, telephone exchangers.
3. System appliances, Limit Switches, Sensors Thermostats and Transducers etc.
4. Signal transmission between circuits of different potentials and impedances.

Outside Dimension : Unit (mm)

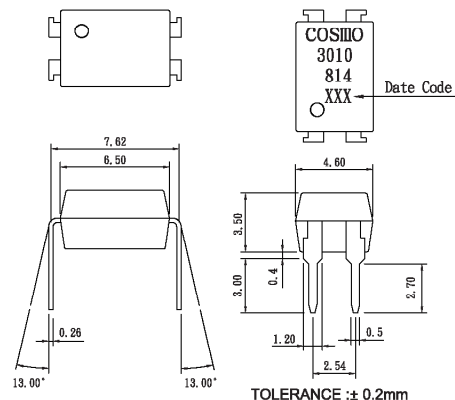

Schematic : Top View

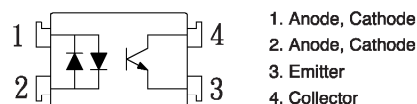

Absolute Maximum Ratings

(Ta=25°C)

Parameter	Symbol	Rating	Unit	
Input	Forward current	I_F	± 60	mA
	Peak forward current	I_{FM}	± 1	A
	Power dissipation	P_D	70	mW
Output	Collector-emitter voltage	V_{CEO}	60	V
	Emitter-collector voltage	V_{ECO}	6	V
	Collector current	I_C	50	mA
	Collector power dissipation	P_C	150	mW
Total power dissipation	P_{tot}	200	mW	
Isolation voltage 1 minute	V_{iso}	5000	Vrms	
Operating temperature	T_{opr}	-30 to +100	°C	
Storage temperature	T_{stg}	-55 to +125	°C	
Soldering temperature 10 second	T_{sol}	260	°C	

Electro-optical Characteristics

(Ta=25°C)

Parameter	Symbol	Conditions	MIN.	TYP.	MAX.	Unit	
Input	Forward voltage	V_F	$I_F = \pm 20\text{mA}$	—	1.2	1.4	V
	Peak forward voltage	V_{FM}	$I_{FM} = \pm 0.5\text{A}$	—	—	3.0	V
	Terminal capacitance	C_t	$V = 0, f = 1\text{kHz}$	—	30	—	pF
Output	Collector dark current	I_{CEO}	$V_{CE} = 20\text{V}, I_F = 0$	—	—	0.1	uA
Transfer characteristics	Current transfer ratio	CTR	$I_F = \pm 1\text{mA}, V_{CE} = 5\text{V}$	60	—	600	%
	Collector-emitter saturation voltage	$V_{CE(sat)}$	$I_F = \pm 20\text{mA}, I_C = 1\text{mA}$	—	0.1	0.3	V
	Isolation resistance	Riso	DC500V	5×10^{10}	10^{11}	—	ohm
	Floating capacitance	C_f	$V = 0, f = 1\text{MHz}$	—	0.6	1.0	pF
	Cut-off frequency	f_c	$V_{CC} = 5\text{V}, I_C = 2\text{mA}, R_L = 100\text{ohm}$	—	80	—	kHz
	Response time (Rise)	t_r	$V_{CE} = 2\text{V}, I_C = 2\text{mA}, R_L = 100\text{ohm}$	—	5	20	us
Response time (Fall)	t_f	—		4	20	us	

Classification table of current transfer ratio is shown below.

Model NO.	Rank mark	CTR (%)
K3010	A	60 TO 600
K3010	B	60 TO 300

Fig.1 Current Transfer Ratio vs. Forward Current

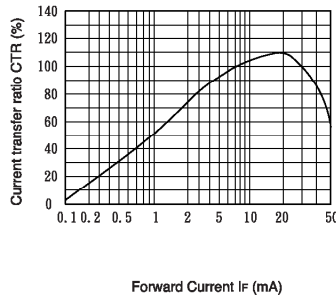

Fig.2 Collector Power Dissipation vs. Ambient Temperature

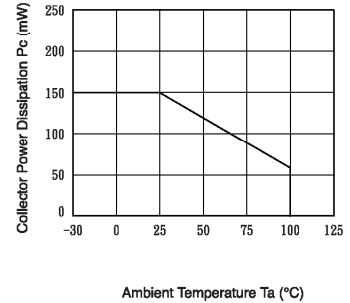

Fig.3 Collector Dark Current vs. Ambient Temperature

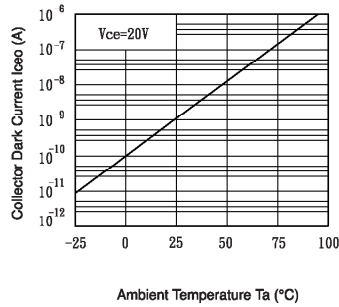

Fig.4 Forward Current vs. Ambient Temperature

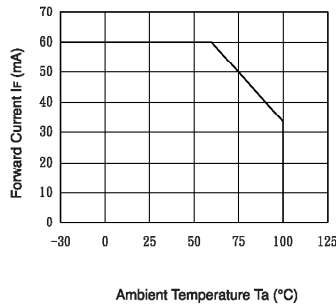

Fig.5 Forward Current vs. Forward Voltage

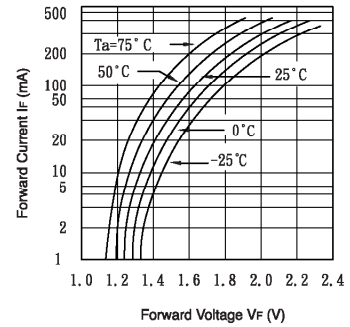

Fig.6 Collector Current vs. Collector-emitter Voltage

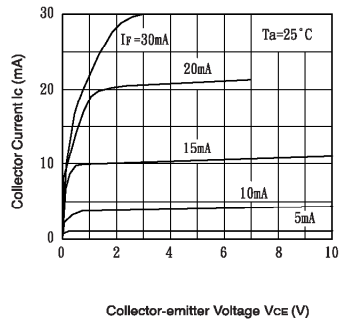

Fig.7 Relative Current Transfer Ratio vs. Ambient Temperature

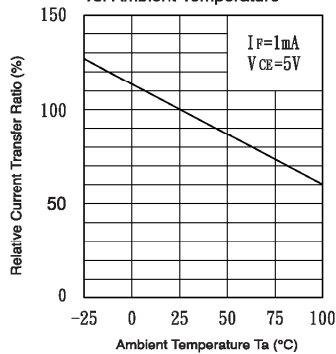

Fig.8 Collector-emitter Saturation Voltage vs. Ambient Temperature

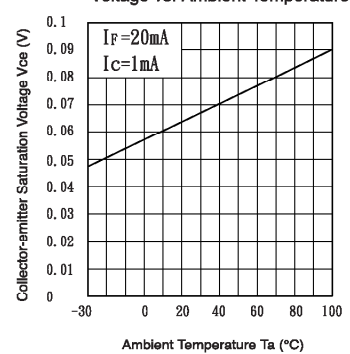

Fig.9 Collector-emitter Saturation Voltage vs. Forward Current

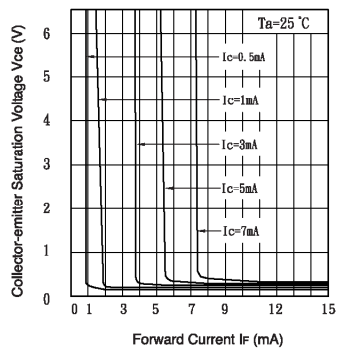

Fig.10 Response Time vs. Load Resistance

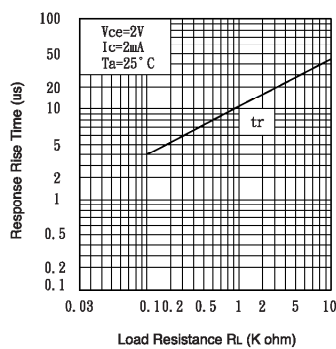

Fig.11 Response Time vs. Load Resistance

