

# SPECIFICATION FOR APPROVAL

REF. :

PROD. NAME	Shielded SMD Power Inductor	ABC'S DWG NO.	HC0312□□□□S□-□□□		
		REV.	20171117-D	PAGE	1

**I . Configuration and dimensions :**

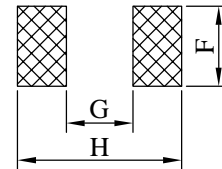
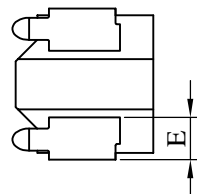
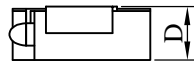
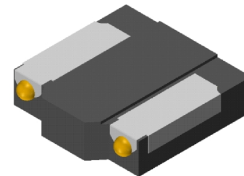
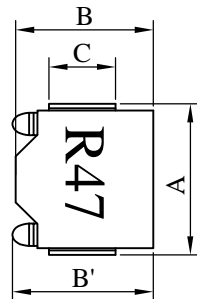

( PCB Pattern )

Unit : m/m

A	B	B'	C	D	E	F	G	H
3.40 ±0.2	3.10 ±0.2	3.40 max.	1.60 ref.	1.20 max.	0.95 ±0.1	1.80 ref.	1.50 ref.	3.70 ref.

**II . Description :**

- a . Powder molding construction
- b . Magnetically shielded
- c . Enamelled copper wire : F class
- d . Product weight : 0.06g ( ref. )
- e . Moisture sensitivity Level 2a
- f . Products comply with RoHS' requirements
- g . Halogen free

**III . General specification :**

- a . Storage temp. : -40°C ----+125°C
- b . Operating temp. : -40°C ----+125°C  
( Temp. rise included )
- c . Resistance to solder heat : 260°C .10 secs.

Peak Temp : 260°C max.  
Max. Peak Temp -5°C : 30sec max.  
Max time above 217°C : 60sec~150sec max.

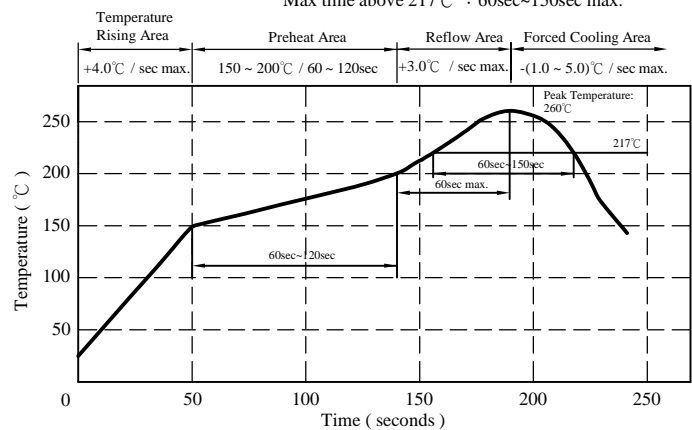

AR-001C

# SPECIFICATION FOR APPROVAL

REF. :

PROD. NAME	Shielded SMD Power Inductor	ABC'S DWG NO.	HC0312□□□□S□-□□□		
		REV.	20171117-D	PAGE	2

IV . Electrical characteristics :

DWG. No.	Inductance ( uH )	RDC ( mΩ )		Isat ( A ) typ.	Irms ( A ) typ.
		typ.	max.		
HC0312R47KS□-□□□	0.47 ±10%	15.0	18.0	6.5	6.1
HC0312R68KS□-□□□	0.68 ±10%	25.5	29.5	5.7	4.8
HC03121R0KS□-□□□	1.00 ±10%	43.2	50.0	4.7	3.5
HC03121R5KS□-□□□	1.50 ±10%	58.0	68.0	4.0	3.2
HC03122R2KS□-□□□	2.20 ±10%	99.0	118.0	3.0	2.4

- 1). Electrical specifications at 25°C
- 2). Inductance test condition. :100kHz / 1V
- 3). Isat base on  $\Delta L / L0A=30\%$  typ.(Approximately transient current)
- 4). Irms base on Temp. rise 40°C typ.

# SPECIFICATION FOR APPROVAL

REF. :

PROD. NAME	Shielded SMD Power Inductor	ABC'S DWG NO.	HC0312□□□□S□-□□□		
		REV.	20171117-D	PAGE	3

V . Curve :

HC0312R47KS□

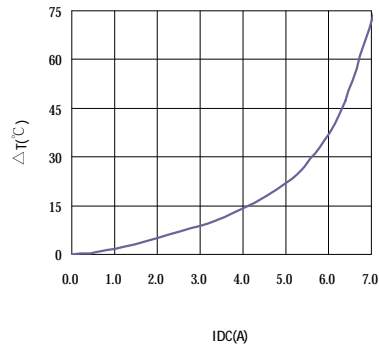
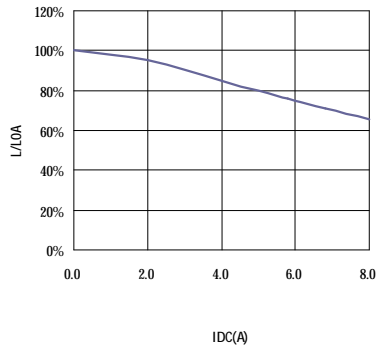

HC03121R0KS□

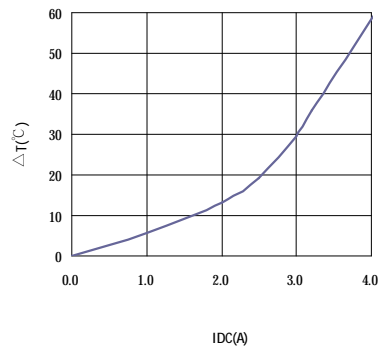
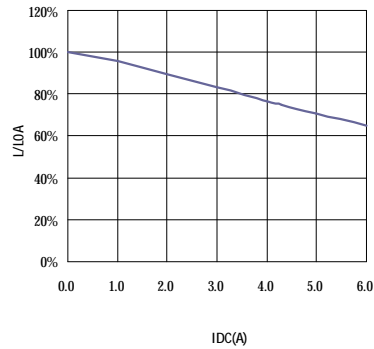

HC03121R5KS□

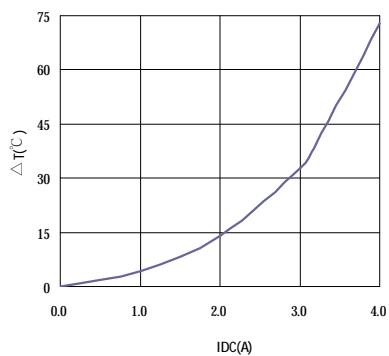
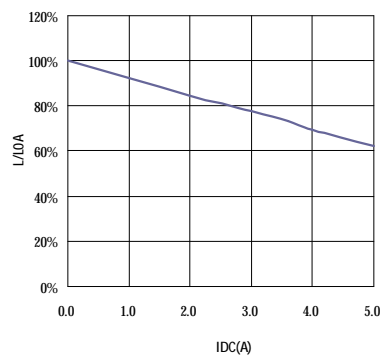

AR-001C

# SPECIFICATION FOR APPROVAL

REF. :

PROD. NAME	Shielded SMD Power Inductor	ABC'S DWG NO.	HC0312□□□□S□-□□□		
		REV.	20171117-D	PAGE	4

## VI . Packaging information :

### (1) Configuration

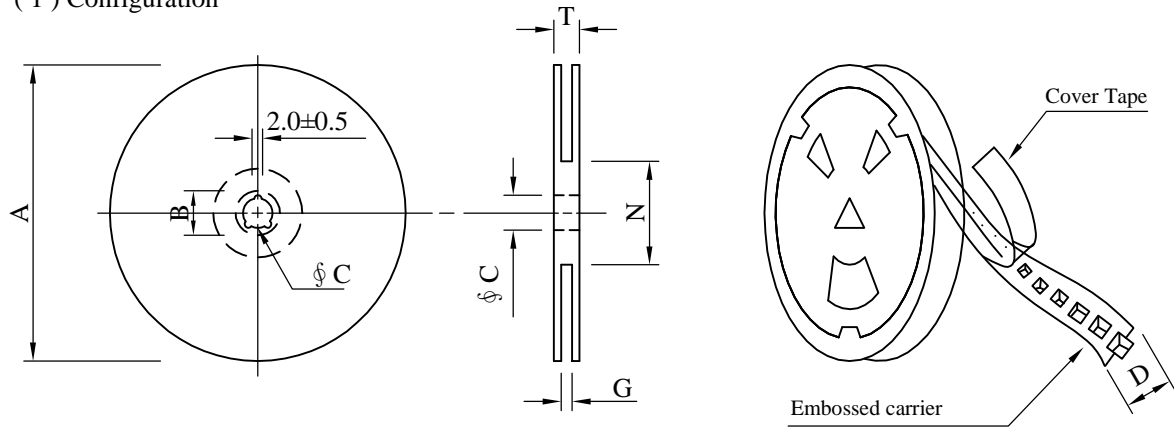

※Carrier tape width : D

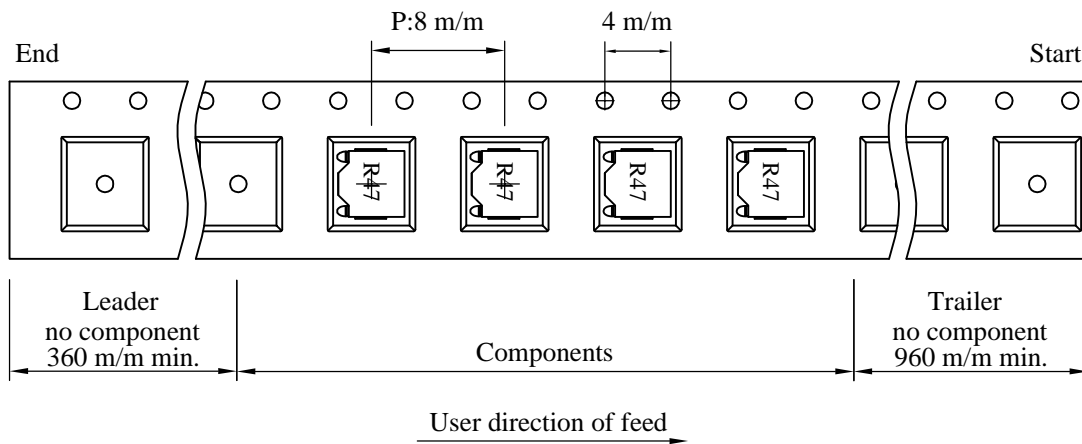

### (2) Dimensions

Unit:m/m

Style	A	B	C	D	G	N	T
13 - 12	330	21±0.8	13±0.5	12	14 <sup>+0</sup>	50 <sup>-0</sup>	18.4

### (3) Q'TY & G.W. Per package

Code	Inner : Reel			Outer : Carton		
	Q'TY (pcs)	G.W. (g)	Style	Q'TY (pcs)	G.W. (Kg)	Size (cm)
B	4,500	750	13 - 12	27,000	7.5	38 x 37 x 22

AR-001C

# SPECIFICATION FOR APPROVAL

REF. :

PROD. NAME	Shielded SMD Power Inductor	ABC'S DWG NO.	HC0312□□□□S□-□□□		
		REV.	20171117-D	PAGE	5

VII . Drawing number expression :

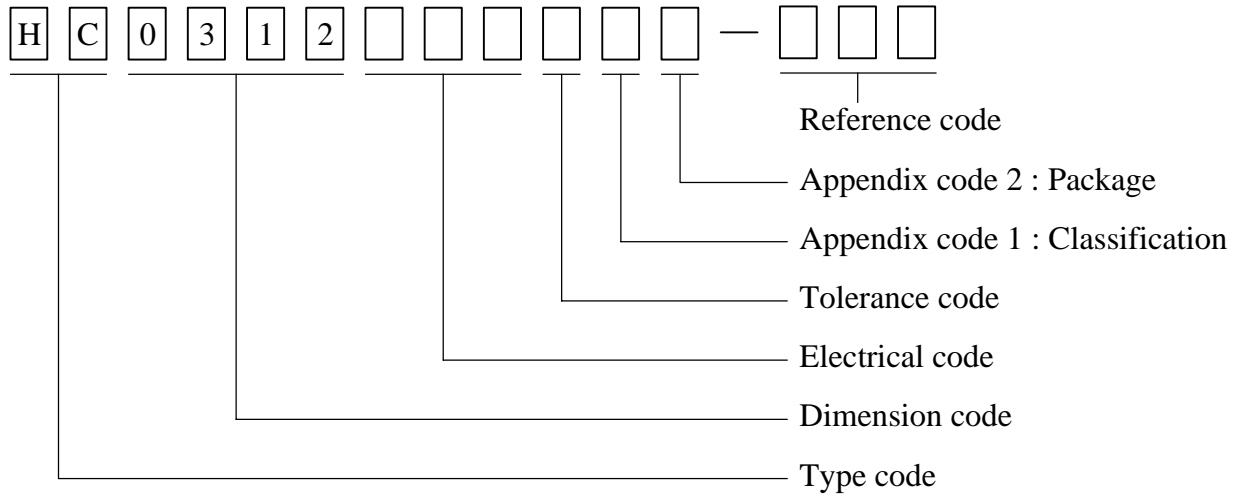

Appendix code 1 : Product Classification

Appendix code 2 : Package Information

Code	Inner package	Cover tape	Carrier tape	Bag	Package Q'TY	Remark
B	T/R (Reel package)	Heat seal	Non-antistatic	Non-antistatic	4,500 pcs	

AR-001C

# SPECIFICATION FOR APPROVAL

REF. :

<b>PROD. NAME</b>	<b>Shielded SMD Power Inductor</b>	<b>ABC'S DWG NO.</b>	HC0312□□□□S□-□□□		
		<b>REV.</b>	20171117-D	<b>PAGE</b>	6

### VIII . Reliability test :

Item	Reference documents	Test Condition	Test Specification
1.High Temperature Exposure	MIL-STD-202 Method 108	1.Temperature: 125±2℃ 2.Time:96±2 hours.	1.No mechanical or electrical damage. 2.Inductance shall not change more than ±20%.
2.Temperature Cycling	JESD22-A 104	1.Temperature: -40℃ ~ +125℃ 2.Number of cycle:100 cycle 3.Dwell time:30 minutes	1.No mechanical or electrical damage. 2.Inductance shall not change more than ±20%.
3.Biased Humidity Test	MIL-STD-202 Method 103	1.Temperature : 85±2 ℃ 2.Humidity: 85% RH. 3.Time:96±2 Hours	1.No mechanical or electrical damage. 2.Inductance shall not change more than ±20%.
4.Operational Life	JESD22-A 108	1.Temperature: 125℃ (Temp. rise included) 2.Time:96±2 hours. 3.Rated current	1.No mechanical or electrical damage. 2.Inductance shall not change more than ±20%.
5.External Visual	JESD22-B 101 & MIL-STD-883 Method 2009	Inspect product constructions, marking and workmanship.	1.No pollution on the surface of products. 2.Clear marking. 3.No crack.
6.Physical Dimensions	JESD22-B 100	Verify physical dimensions to the applicable product detail specification.	Per product specification standard
7.Resistance to solvents	MIL-STD-202 Method 215	Immerse into solvent for 3±0.5 minutes & brush 10 times for 3 cycles.	1.No body change in appearance. 2.No marking blurred. 3.Inductance shall not change more than ±20%.
8.Vibration Test	MIL-STD-202 Method 204	1.Frequency and Amplitued : 10-2000-10 Hz, 1.5 mm. 2.Direction:X, Y, Z 3.Test duration:2 hours for each direction, 6 hours in total.	1.No mechanical or electrical damage. 2.Inductance shall not change more than ±20%.
9.Resistance To Soldering Heat Test	MIL-STD-202 Method 210 & J-STD020D.1	1.Highest temperature : 260±5℃. 2.Time ( temp. ≥ 217℃ ) : 60~150 Seconds. 3.IR reflow times : 3 times.	1.No mechanical or electrical damage. 2.Inductance shall not change more than ±20%.
10.Saturation Current	JIS C 6436 & User SPEC.	1.Applied rated current for 5 seconds. 2.Saturation current	Inductance shall not drop more than 30% typ.
11.Over load	JIS C 6436 & User SPEC.	1.Applied one and half rated current for a period of 5 minutes. 2.Rated current	No electrical or mechanical damage
12.Temperature Rise Current	JIS C 6436 & User SPEC.	1.Applied rated current for 10 minutes. 2.Temperature measure by digital surface thermometer. 3.Irms current	Surface temperature rise is less than 40℃ typ.
13.Solderability Test	J-STD-002 & JESD22-B 102	1.Baking in pre-testing : 150±5℃ / 16Hours±30 min. 2.Peak temperature : 240±5℃ 3.Time ( temp. ≥ 217℃ ) : 60~150 seconds. 4.IR reflow times : 1 time.	More than 95% soldering coverage min on terminations.
14.Electrical Characteriazation	MIL-STD-202 Method 304 & User SPEC.	1.Operating temperature : -40℃~125℃ 2.Room temperature : 25℃.	1.No mechanical or electrical damage. 2.Inductance shall not change more than ±20%.
15.Drop	CNS-C6354 & GB/T 2423.8	1.Products shall be mounted on SPEC. PCB and dropped down from a height of 1m 2.Drop total time : 6 times (Every side of sample drop 2 times)	1. Adhesion on PCB shall be enough. 2. Product appearance shall not break. 3. No electrical damage.
16.Terminal Strength Test	IEC 60068-2-21	1.Apply push force to samples mounted on PCB. 2.Force of 1.8 kg for 60±1 seconds.	After test, inductors shall be no mechanical damage.

AR-001C

# SPECIFICATION FOR APPROVAL

REF. :

PROD. NAME	Shielded SMD Power Inductor	ABC'S DWG NO.	HC0312□□□□S□-□□□		
		REV.	20171117-D	PAGE	7

IX . Change history :

DATE/REV.	DISCRIPTION	DRAWN	CHECKED	APPROVED
20170626-A	Released	Colin	Leo	Nick
20170717-B	Change the Outer Carton Size (cm) : 36 x 36 x 20 → 38 x 37 x 22	Miz	Nick	Nick
20170802-C	Add Inductor HC03121R5KS□-□□□	Colin	Leo	Nick
20171117-D	1. Change Carrier tape's description 2. Modify the Electrical characteristics 3. Remove HC03122R2KS□-□□□ curve	Sammy	Leo	Nick

AR-001C