





Product Specification				
	Model: GVTW50TPFB1R0	Rev. No.	Issued Date.	Page.
		A	2016/02/18	1 / 24

Thin-Film-Transistor LCD Module
Model: GVTW50TPFB1R0

Acceptance

Solomon Goldentek Display Corp.
NO. 18 Ta-Yeh St., Ta-Fa Industrial Park, Ta-Liao
Hsiang, Kaohsiung Hsien 831, TAIWAN , R.O.C.
 FAX: 886-7-7886800

Approved and Checked by

Approved by	Checked by		Made by
			

Product Specification



Model: GVTW50TPFB1R0

Rev. No.

Issued Date.

Page.

A

2016/02/18

2 / 24

Revise Records

Rev.	Date	Contents	Written	Approved
A	2016/02/18	Preliminary Specification	Marcus Huang	Oliver Lee

Special Notes

Note1.	
Note2.	
Note3.	
Note4.	
Note5.	

Product Specification				
	Model: GVTW50TPFB1R0	Rev. No.	Issued Date.	Page.
		A	2016/02/18	3 / 24

Contents

1.	General Description and Features	4
1.1	Features	4
1.2	LCD Module	4
2.	Mechanical Information	4
3.	Electrical Specifications	5
3.1	Absolute Max. Ratings	5
3.2	AC Timing Characteristic of The LCD	8
3.3	Back-Light Unit	10
4.	Optical Characteristics	11
4.1	Optical characteristic of the LCD	11
5.	I/O Terminal	14
5.1	Pin Assignment	14
5.2	Block Diagram	16
6.	Displayed Color and Input Data	17
7.	Touch Screen Panel Specifications	18
8.	Reliability Condition	19
9.	Dimensional Outlines	20
10.	Incoming Inspection Standards	21

Product Specification

	Model: GVTW50TPFB1R0	Rev. No.	Issued Date.	Page.
		A	2016/02/18	4 / 24

1. General Description and Features

GVTW50TPFB1R0 is a transmissive type color active matrix TFT (Thin Film Transistor) liquid crystal display (LCD) that uses amorphous silicon TFT as a switching device. This model is composed of a TFT-LCD module, a driver circuit, Touch panel and a back-light unit. Graphics and texts can be displayed on a WVGA 800 (W) x 3 x 480 (H) dots (15:9 aspect ratio) with 16.7M colors by supplying 24 bits data signal (8 bits/each color). The following table described the features of GVTW50TPFB1R0.

1.1 Features

- Transmissive and back-light with 24 LEDs are available.
- TN (Twisted Nematic) mode.
- Digital RGB (8 bits/color) data transfer.
- Data enable mode.
- 4-wire Touch panel
- ROHS Compliance

1.2 LCD Module

Item	Specification	Unit
Screen Size	5.0 inches	Diagonal
Display Resolution	800 (H) x 480 (V)	Pixel
Active Area	108 (H) x 64.8 (V)	mm
Outline Dimension	118.5 (H) x 77.55 (V) x 3.9 (T)	mm
Display Mode	Normally white mode/ Transmissive	--
Pixel Arrangement	R,G,B Vertical Stripe	--
Pixel Size	135 x 135	um
Display Color	16.7 M	--
Viewing Direction	6 o'clock	--
Input Interface	Digital RGB (8 bits/color) Data Transfer	--

2. Mechanical Information

Item		Min.	Typ.	Max.	Unit	Note
Module Size	Horizontal (H)	118.35	118.5	118.65	mm	
	Vertical (V)	77.4	77.55	77.70	mm	
	Thickness (T)	3.6	3.9	4.2	mm	(1)
Weight		--	TBD	--	g	--

Note (1) Not Include Component . Refer to the Outline Dimension Drawing as attached.

Product Specification

	Model: GVTW50TPFB1R0	Rev. No.	Issued Date.	Page.
		A	2016/02/18	5 / 24

3. Electrical Specifications

3.1 Absolute Max. Ratings

3.1.1 Absolute Ratings of Environment

If the operating condition exceeds the following absolute maximum ratings, the TFT LCD module may be damaged permanently.

($T_a=25\pm 2^{\circ}\text{C}$, $V_{SS}=\text{GND}=0$)

Item	Symbol	Min.	Max.	Unit	Note
Storage temperature	T_{STG}	-30	85	$^{\circ}\text{C}$	(1)
Operating temperature	T_{OPR}	-30	85	$^{\circ}\text{C}$	(1,2,3)

Note (1) 95 % RH Max. ($40^{\circ}\text{C} \geq T_a$). Maximum wet-bulb temperature at 39°C or less. ($T_a > 40^{\circ}\text{C}$) No condensation.

Note (2) In case of below 0° , the response time of liquid crystal (LC) becomes slower and the color of panel becomes darker than normal one. Level of retardation depends on temperature, because of LC's character

Note (3) Only operation is guaranteed at operating temperature. Contrast, response time, another display quality are evaluated at $+25^{\circ}\text{C}$.

Product Specification



Model: GVTW50TPFB1R0

Rev. No.

Issued Date.

Page.

A

2016/02/18

6 / 24

3.1.2 Electrical Absolute Maximum Ratings

($V_{SS}=GND=0$)

Parameter	Symbol	Min.	Max.	Unit	Remark
Digital Supply Voltage	VDD	-0.5	5.0	V	

Display On/Off Sequence :

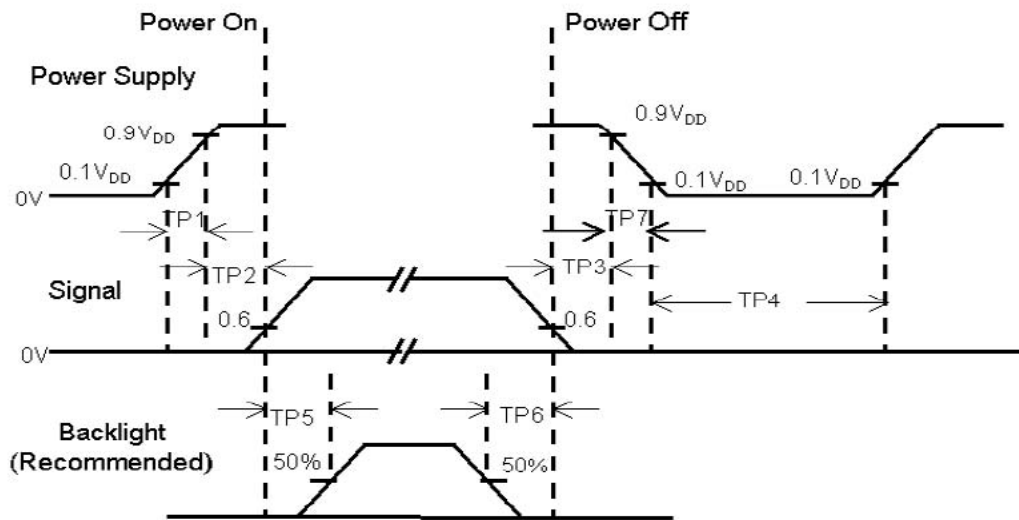

Note :

- (1) The supply voltage of the external system for the module input should be the same as the definition of V_{DD} .
- (2) Apply the lamp voltage within the LCD operation range. When the back-light turns on before the LCD operation or the LCD turns off before the back-light turns off, the display may momentarily become white.
- (3) In case of $V_{DD} = \text{off level}$, please keep the level of input signal on the low or keep a high impedance.
- (4) TP4 should be measured after the module has been fully discharged between power off and on period.
- (5) Interface signal shall not be kept at high impedance when the power is on.

Product Specification

	Model: GVTW50TPFB1R0	Rev. No.	Issued Date.	Page.
		A	2016/02/18	7 / 24

3.1.3 DC Electrical Characteristics of the TFT LCD

(Ta=25±2°C, V_{SS}=GND=0)

Item	Symbol	Min.	Typ.	Max.	Unit	Remark
Power supply	VDD	3.0	3.3	3.6	V	
Input Voltage for logic	H Level	V _{IH}	0.7xVDD	-	VDD	V
	L Level	V _{IL}	0	-	0.3xVDD	V
Power Supply current	IDD	-	TBD	-	mA	Note 1

Note1: The specified power consumption is under the conditions at VDD=3.3V,
FV=60Hz, whereas a power dissipation check pattern below is displayed.

Black Pattern / 0 Gray



Active Area

Product Specification

	Model: GVTW50TPFB1R0	Rev. No.	Issued Date.	Page.
		A	2016/02/18	8 / 24

3.2 AC Timing Characteristic of The LCD

3.2.1 Timing Condition (DE mode)

Horizontal input timing

Parameter	Symbol	Value			Unit
		Min.	Typ.	Max.	
Horizontal Display Area	thd	800			DCLK
DCLK Frequency	fclk	-	30	50	MHZ
One Horizontal Line	th	889	928	1143	DCLK
HS pulse width	thpw	1	48	255	DCLK
HS Back Porch (Blanking)	thb	88			DCLK
HS Front Porch	thfb	1	40	255	DCLK
DE mode Blanking	th-thd	85	128	512	DCLK

Vertical input timing

Parameter	Symbol	Value			Unit
		Min.	Typ.	Max.	
Vertical Display Area	tvd	480			H
VS period time	tv	513	525	767	H
VS pulse width	tvpw	3	3	255	H
VS Back Porch (Blanking)	tvb	32			H
VS Front Porch	tvfb	1	13	255	H
DE mode Blanking	tv-tvd	4	45	255	H

Product Specification



Model: GVTW50TPFB1R0

Rev. No.

Issued Date.

Page.

A

2016/02/18

9 / 24

Timing Characteristic 3.2.2.1 DE and RGB Input Timing

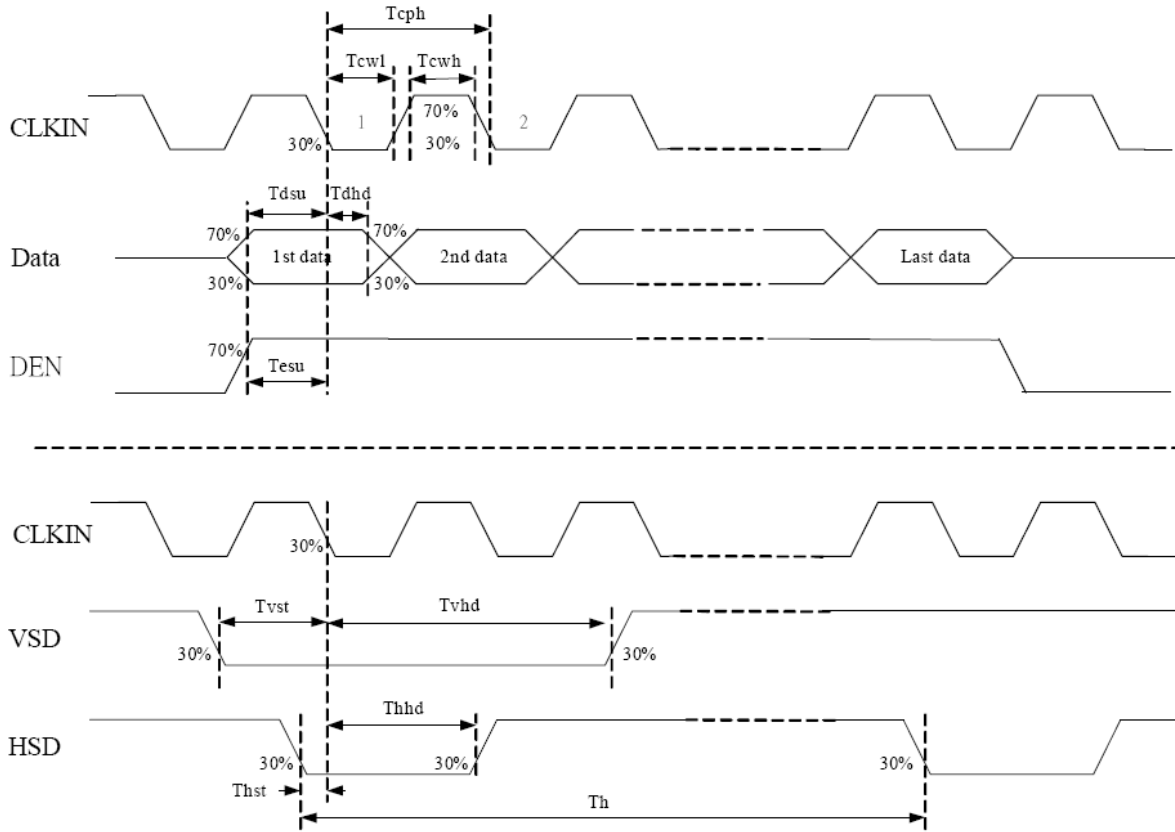

Product Specification

	Model: GVTW50TPFB1R0	Rev. No.	Issued Date.	Page.
		A	2016/02/18	10 / 24

3.3 Back-Light Unit

The Back-light system is an edge-lighting type with 24 white LED (Light Emitting Diode)s. The characteristics of 24 white LEDs are shown in the following tables.

(Ta= Room Temp)

Characteristics	Symbol	Min.	Typ.	Max.	Unit	Note
Forward Voltage	V_f	(11.2)	(12.8)	(13.6)	V	
Forward Current	I_f	-	120	-	mA	(1)
Power Consumption	P_{BL}	-	1536	-	mW	(2)
LED Life time	-	50000	-	-	hr	(3)

Note (1) LEDs in 4 series x 6 parallel type.

(2) Where $I_f = 120\text{mA}$, $V_f = 12.8\text{V}$, $P_{BL} = V_f \times I_f$

(3) The environmental conducted under ambient air flow ,at $T_a=25\pm 2^\circ\text{C}$, 60%RH $\pm 5\%$

Product Specification

	Model: GVTW50TPFB1R0	Rev. No.	Issued Date.	Page.
		A	2016/02/18	11 / 24

4. Optical Characteristics

4.1 Optical characteristic of the LCD

The following items are measured under stable conditions. The optical characteristics should be measured in a dark room or equivalent state with the methods.

Measuring equipment: BM-7A

Item	Symbol	Condition	Min	Type	Max	Unit	Note	
Brightness	B		720	800	--	cd/m ²		
Response time	T _r	θ=0°	-	5	--	ms	.	
	T _f		--	15	--	ms		
Contrast ratio	CR	At optimized viewing angle	--	350	--	--		
Luminance Uniformity	ΔL		70	80		%		
Color Chromaticity (CIE 1931)	White	θ=0° Normal Viewing Angle	W _x	0.281	0.311	0.341	--	BM-7A
			W _y	0.294	0.324	0.354		
Viewing Angle (6H)	Hor.	CR≥10	θ _R	60	65	--	Degree	
			θ _L	60	65	--		
	Ver.		θ _U	45	50	--		
			θ _D	55	60	--		

Product Specification

	Model: GVTW50TPFB1R0	Rev. No.	Issued Date.	Page.
		A	2016/02/18	12 / 24

a. Test equipment setup

After stabilizing and leaving the panel alone shall be warmed up for the stable operation of LCM, the measurement should be executed. Measurement should be executed in a stable, windless, and dark room. Optical specifications are measured by Topcon BM-7(fast) with a viewing angle of 2° at a distance of 50cm and normal direction.

b. Definition of response time: Tr and Tf

The response time is defined as the following figure and shall be measured by switching the input signal for "black" and "white".

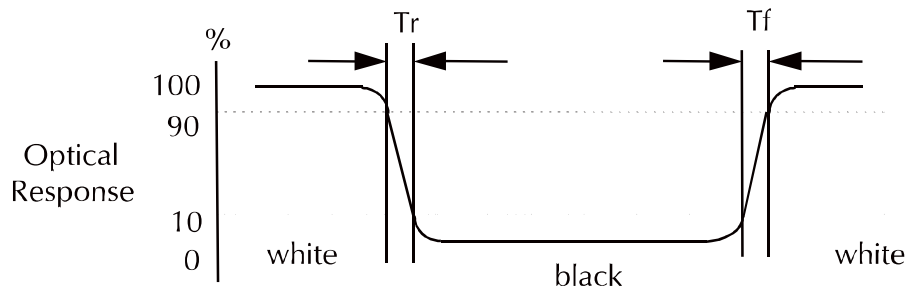

c. Definition of contrast ratio:

$$\text{Contrast Ratio (CR)} = \frac{\text{Brightness measured when LCD is at "white state"}}{\text{Brightness measured when LCD is at "black state"}}$$

d. Measured at the center area of the panel when all the input terminals of LCD panel are electrically opened.

Product Specification

	Model: GVTW50TPFB1R0	Rev. No.	Issued Date.	Page.
		A	2016/02/18	13 / 24

e. View Angle

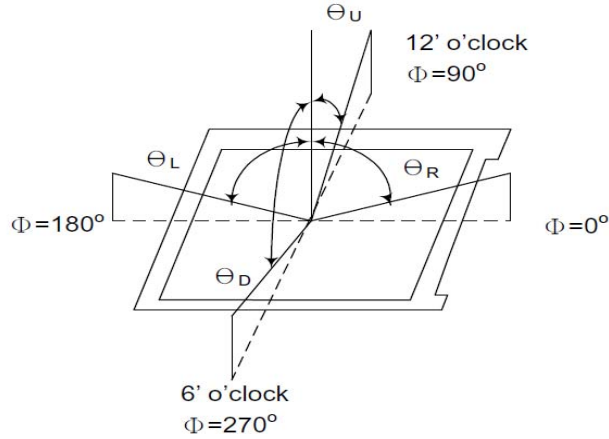

f. Definition of Luminance of White: Luminance of white at the center points

Light Source of Back-Light Unit	LED Type
---------------------------------	----------

g. Definition of White Uniformity

$$\text{White Uniformity} = \frac{\text{Min. luminance of white among 9-points}}{\text{Max. luminance of white among 9-points}} \times 100\%$$

h. The definition of Color Gamut -Color Chromaticity CIE 1931

Color coordinate of white & red, green, blue at center point.

Color Gamut : NTSC(%) = (RGB Triangle Area / NTSC Triangle Area) x 100

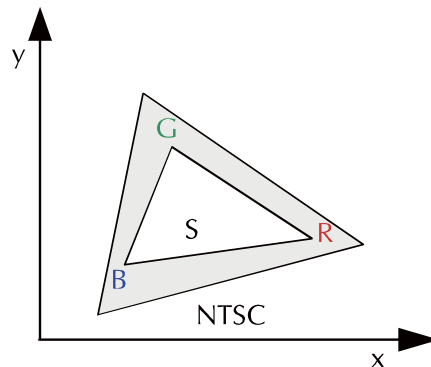

Product Specification

	Model: GVTW50TPFB1R0	Rev. No.	Issued Date.	Page.
		A	2016/02/18	14 / 24

5. I/O Terminal

5.1 Pin Assignment

Pin No.	Symbol	I/O	Function	Remark
1	VLED-	P	Power for LED backlight cathode	
2	VLED+	P	Power for LED backlight anode	
3	GND	P	Power Ground	
4	VDD	P	Power Supply	
5	R0	I	Red data signal (LSB)	
6	R1	I	Red data signal	
7	R2	I	Red data signal	
8	R3	I	Red data signal	
9	R4	I	Red data signal	
10	R5	I	Red data signal	
11	R6	I	Red data signal	
12	R7	I	Red data signal (MSB)	
13	G0	I	Green data signal (LSB)	
14	G1	I	Green data signal	
15	G2	I	Green data signal	
16	G3	I	Green data signal	
17	G4	I	Green data signal	
18	G5	I	Green data signal	
19	G6	I	Green data signal	
20	G7	I	Green data signal (MSB)	
21	B0	I	Blue data signal (LSB)	
22	B1	I	Blue data signal	
23	B2	I	Blue data signal	
24	B3	I	Blue data signal	
25	B4	I	Blue data signal	
26	B5	I	Blue data signal	
27	B6	I	Blue data signal	
28	B7	I	Blue data signal (MSB)	
29	DGND	P	Digital ground	
30	DCLK	I	Pixel clock	
31	DISP	I	Display on/ off	
32	HSYNC	I	Horizontal sync signal	
33	VSYNC	I	Vertical sync signal	
34	DE	I	Data Enable signal	
35	NC	I	No Connect	

Product Specification

	Model: GVTW50TPFB1R0	Rev. No.	Issued Date.	Page.
		A	2016/02/18	15 / 24

36	GND	P	Power Ground	
37	XR	I	Touch panel Right	
38	YB	I	Touch panel Bottom	
39	XL	I	Touch panel Left	
40	YT	I	Touch panel Top	

I: Input, O: Output, P: Power

Notes:

- 1) NC Pin must be retained; this pin can't contact GND or other signal.
- 2) GND Pin must ground contact, can not be floating.
- 3) Connector Part No: FH12A-40S-0.5SH(55) or equivalent.

Product Specification



Model: GVTW50TPFB1R0

Rev. No.

Issued Date.

Page.

A

2016/02/18

16 / 24

5.2 Block Diagram

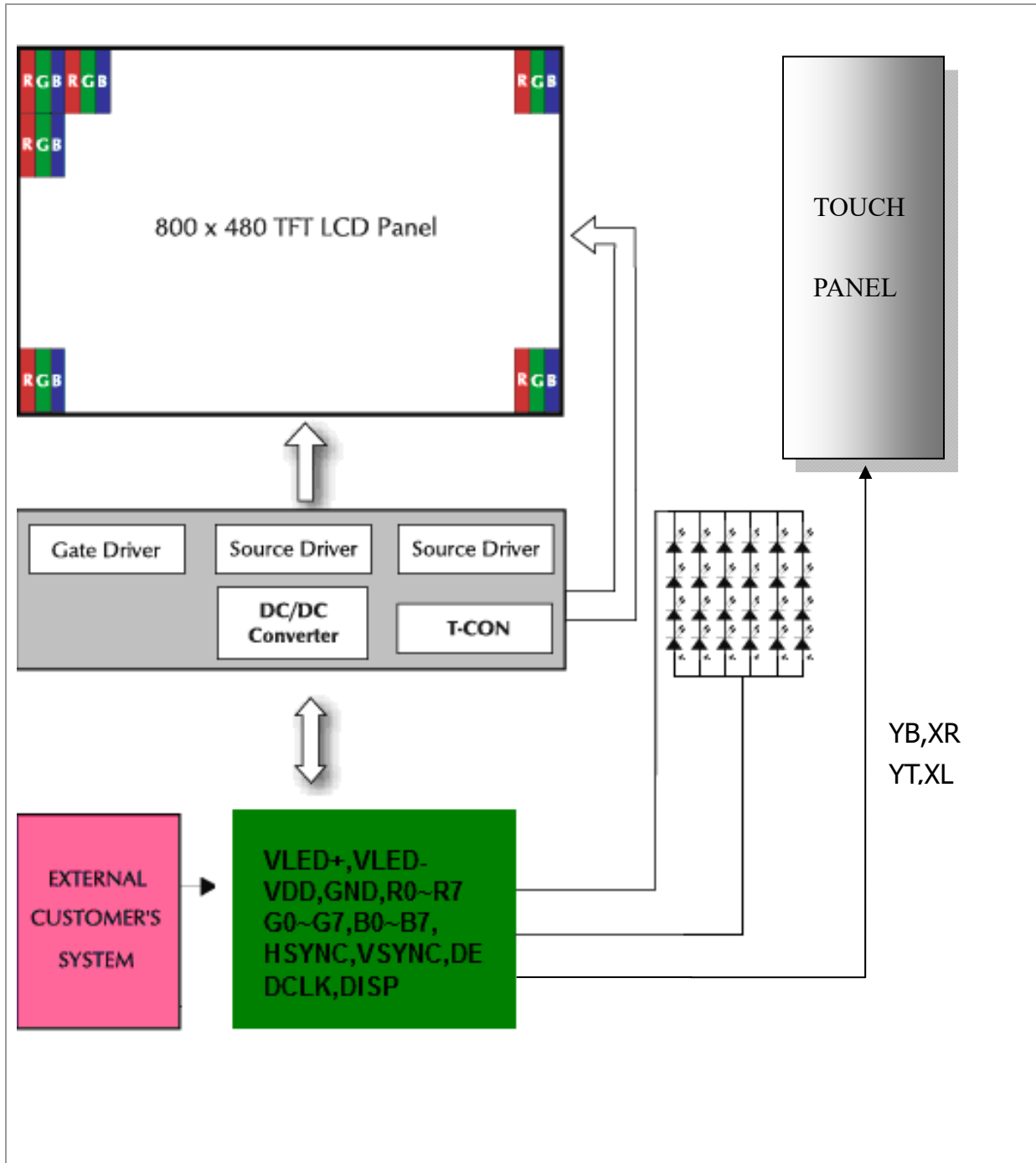

Product Specification

	Model: GVTW50TPFB1R0	Rev. No.	Issued Date.	Page.
		A	2016/02/18	17 / 24

6. Displayed Color and Input Data

	Color & Gray Scale	Data Signal																							
		R7	R6	R5	R4	R3	R2	R1	R0	G7	G6	G5	G4	G3	G2	G1	G0	B7	B6	B5	B4	B3	B2	B1	B0
Basic Color	Black	0	0	0	0	0	0	0	0	0	0	0	0	0	0	0	0	0	0	0	0	0	0	0	
	Red	1	1	1	1	1	1	1	1	0	0	0	0	0	0	0	0	0	0	0	0	0	0	0	
	Green	0	0	0	0	0	0	0	0	1	1	1	1	1	1	1	1	0	0	0	0	0	0	0	
	Blue	0	0	0	0	0	0	0	0	0	0	0	0	0	0	0	0	1	1	1	1	1	1	1	
	Cyan	0	0	0	0	0	0	0	0	1	1	1	1	1	1	1	1	1	1	1	1	1	1	1	
	Magenta	1	1	1	1	1	1	1	1	0	0	0	0	0	0	0	0	1	1	1	1	1	1	1	
	Yellow	1	1	1	1	1	1	1	1	1	1	1	1	1	1	1	1	0	0	0	0	0	0	0	
	White	1	1	1	1	1	1	1	1	1	1	1	1	1	1	1	1	1	1	1	1	1	1	1	
Red	Black	0	0	0	0	0	0	0	0	0	0	0	0	0	0	0	0	0	0	0	0	0	0		
	Red(1)	0	0	0	0	0	0	0	1	0	0	0	0	0	0	0	0	0	0	0	0	0	0		
	Red(2)	0	0	0	0	0	0	1	0	0	0	0	0	0	0	0	0	0	0	0	0	0	0		
	:	:	:	:	:	:	:	:	:	:	:	:	:	:	:	:	:	:	:	:	:	:	:	:	
	Red(127)	0	1	1	1	1	1	1	1	0	0	0	0	0	0	0	0	0	0	0	0	0	0		
	:	:	:	:	:	:	:	:	:	:	:	:	:	:	:	:	:	:	:	:	:	:	:	:	
	Red(254)	1	1	1	1	1	1	1	0	0	0	0	0	0	0	0	0	0	0	0	0	0	0		
	Red(255)	1	1	1	1	1	1	1	1	0	0	0	0	0	0	0	0	0	0	0	0	0	0		
Green	Black	0	0	0	0	0	0	0	0	0	0	0	0	0	0	0	0	0	0	0	0	0	0		
	Green(1)	0	0	0	0	0	0	0	0	0	0	0	0	0	0	0	1	0	0	0	0	0	0		
	Green(2)	0	0	0	0	0	0	0	0	0	0	0	0	0	0	1	0	0	0	0	0	0	0		
	:	:	:	:	:	:	:	:	:	:	:	:	:	:	:	:	:	:	:	:	:	:	:	:	
	Green(127)	0	0	0	0	0	0	0	0	0	1	1	1	1	1	1	1	0	0	0	0	0	0		
	:	:	:	:	:	:	:	:	:	:	:	:	:	:	:	:	:	:	:	:	:	:	:	:	
	Green(254)	0	0	0	0	0	0	0	0	1	1	1	1	1	1	1	0	0	0	0	0	0	0		
	Green(255)	0	0	0	0	0	0	0	0	1	1	1	1	1	1	1	0	0	0	0	0	0	0		
Blue	Black	0	0	0	0	0	0	0	0	0	0	0	0	0	0	0	0	0	0	0	0	0	0		
	Blue(1)	0	0	0	0	0	0	0	0	0	0	0	0	0	0	0	0	0	0	0	0	0	1		
	Blue(2)	0	0	0	0	0	0	0	0	0	0	0	0	0	0	0	0	0	0	0	0	0	1		
	:	:	:	:	:	:	:	:	:	:	:	:	:	:	:	:	:	:	:	:	:	:	:		
	Blue(127)	0	0	0	0	0	0	0	0	0	0	0	0	0	0	0	0	1	1	1	1	1	1		
	:	:	:	:	:	:	:	:	:	:	:	:	:	:	:	:	:	:	:	:	:	:	:	:	
	Blue(254)	0	0	0	0	0	0	0	0	0	0	0	0	0	0	0	1	1	1	1	1	1	0		
	Blue(255)	0	0	0	0	0	0	0	0	0	0	0	0	0	0	0	1	1	1	1	1	1	1		

0 : Low level voltage, 1 :High level voltage

Each basic color can be displayed in 256 gray scales from 8 bit data signals. With the combination of total 24 bit data signals, the 16.7M color display can be achieved on the screen.

Product Specification



Model: GVTW50TPFB1R0

Rev. No.

Issued Date.

Page.

A

2016/02/18

18 / 24

7. Touch Screen Panel Specifications

7.1 Electrical Characteristics

Item	Min.	Typ.	Max.	Unit	Note
Linearity	-1.5	-	1.5	%	Analog X and Y directions
Terminal resistance	(200)	-	(1000)	Ω	X
	(200)	-	(900)	Ω	Y
Insulation resistance	20	-	-	M Ω	DC 25V
Voltage	-	5.0	-	V	DC
Chattering	-	-	10	ms	100k Ω pull-up

Product Specification

	Model: GVTW50TPFB1R0	Rev. No.	Issued Date.	Page.
		A	2016/02/18	19 / 24

8. Reliability Condition

No change on display and in operation under the following test condition.

Condition: Unless otherwise specified, tests will be conducted under the following condition.

Temperature: $20 \pm 5^\circ\text{C}$.

Humidity: $65 \pm 5\% \text{RH}$.

Tests will be not conducted under functioning state.

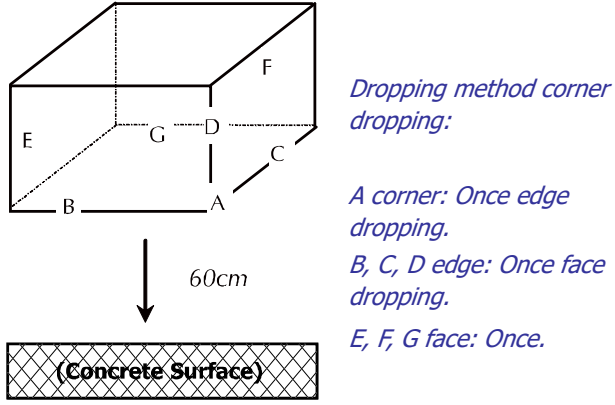
No.	Parameter	Condition	Notes
1	High Temperature Operating	$85^\circ\text{C} \pm 2^\circ\text{C}$, 240hrs (Operation state).	
2	Low Temperature Operating	$-30^\circ\text{C} \pm 2^\circ\text{C}$, 240hrs (Operation state).	1
3	High Temperature Storage	$85^\circ\text{C} \pm 2^\circ\text{C}$, 240hrs.	2
4	Low Temperature Storage	$-30^\circ\text{C} \pm 2^\circ\text{C}$, 240hrs.	1,2
5	High Temperature and High Humidity Operation Test	$60^\circ\text{C} \pm 2^\circ\text{C}$, 90%, 240hrs.	1,2
6	Vibration Test	Total fixed amplitude: 1.5mm. Vibration Frequency: 10~55Hz. One cycle 60 seconds to 3 direction of X, Y, Z each 15 minutes.	3
7.	Drop Test	To be measured after dropping from 60cm high on the concrete surface in packing state. 	

- Notes:
1. No dew condensation to be observed.
 2. The function test shall be conducted after 4 hours storage at the normal temperature and humidity after removed from the test chamber.
 3. Vibration test will be conducted to the product itself without putting I in a container.

Product Specification



Model: GVTW50TPFB1R0

Rev. No.

Issued Date.

Page.

A

2016/02/18

20 / 24

9. Dimensional Outlines

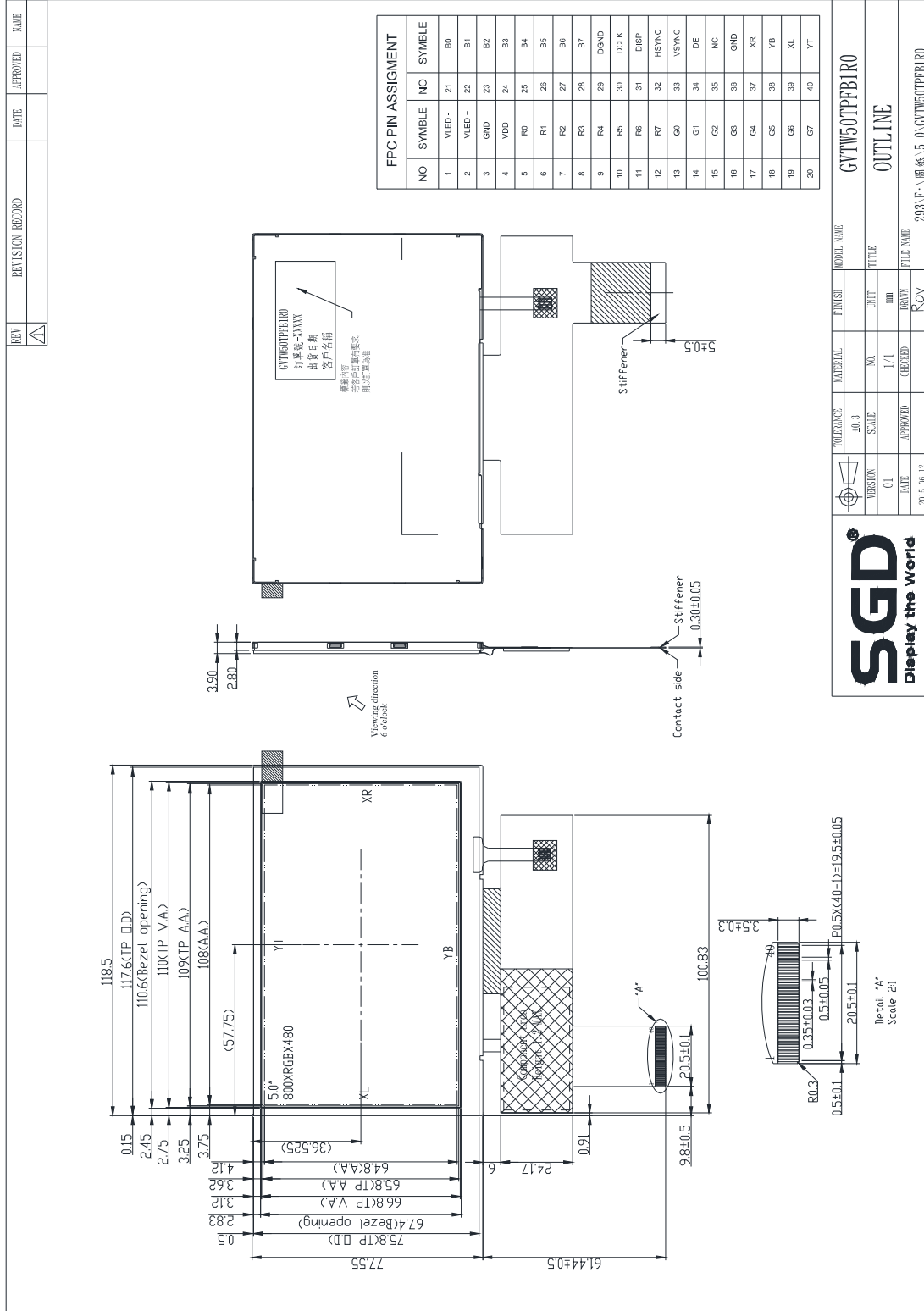

Product Specification

	Model: GVTW50TPFB1R0	Rev. No.	Issued Date.	Page.
		A	2016/02/18	21 / 24

10. Incoming Inspection Standards

9.1 Inspection and Environment Conditions

9.1.1 Inspection Conditions:

- (1) Inspection Distance: 35 cm±5cm
- (2) View Angle : Light-on Inspection Angle : ±5°
Cosmetic Inspection Angle : ±45°

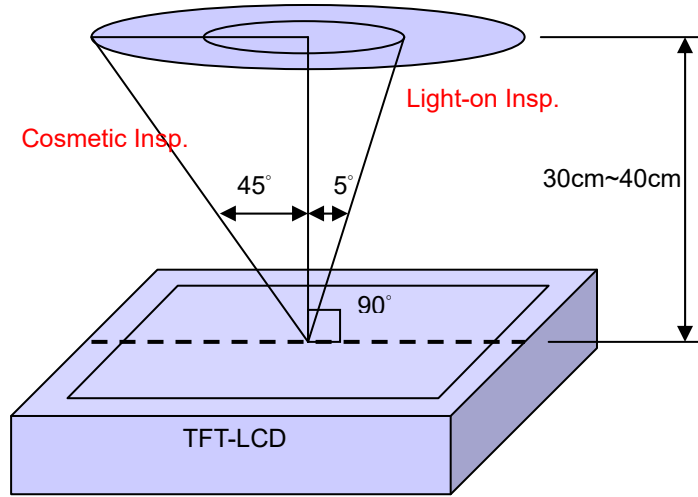

(perpendicular to LCD panel surface)

9.1.2 Environment Conditions:

Ambient Temperature		23°C ±5°C
Ambient Humidity		55±10%RH
Ambient Illumination	Cosmetic Inspection	more than 600 Lux
	Functional Inspection	300~500 Lux

9.1.3 Sampling Conditions:

- (1) Lot Size: Quantity of shipment lot per model
- (2) Sampling Method:

Sampling Plan		MIL-STD-105E
		Normal Inspection, Single Sampling
		Level II
AQL	Major Defect	1.0%
	Minor Defect	1.5%

- (3) The classification of Major(MA) and Minor(MI) defects is shown as 3. Inspection Criteria.

Product Specification

	Model: GVTW50TPFB1R0	Rev. No.	Issued Date.	Page.
		A	2016/02/18	22 / 24

9.1.4 Inspection Criteria

9.1.4.1 Cosmetic Inspection(Panel):

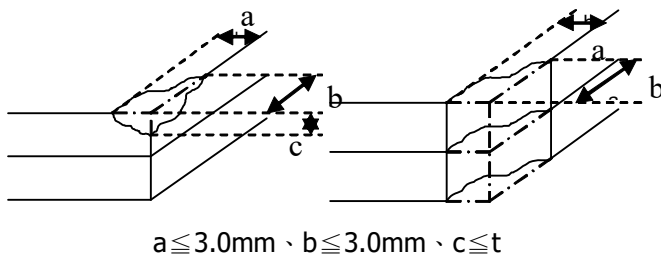
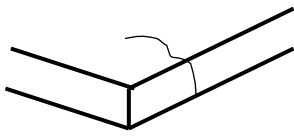
Item	Judgment Criteria	Classification
Chipping on Panel	 <p style="text-align: center;">$a \leq 3.0\text{mm}$、$b \leq 3.0\text{mm}$、$c \leq t$ (Bottom glass thickness)</p>	MA
Scratch on Panel *Note-2	$W \leq 0.05\text{mm}$ or $L < 5\text{mm}$: Ignored $0.05\text{mm} < W \leq 0.1\text{mm}$ and $L \leq 5\text{mm}$: $N \leq 5$ $W > 0.1\text{mm}$ or $L > 5\text{mm}$: Not allowed	MI
Bubble or Dent on Panel *Note-3	$D \leq 0.2\text{mm}$: Ignored $0.2\text{mm} < D \leq 0.3\text{mm}$: $N \leq 5$ $D > 0.3\text{mm}$: Not allowed	MI
Panel Crack	 <p style="text-align: center;">Not Allowed crack</p>	MA
Bezel Deformation	Obvious deformation is not allowed.	MI
Bezel Oxidation	Not allowed if it rusts continuously over 1 cm (It is out of warranty with rusted tin plate)	MI
Bezel Scratch	$L \leq 20\text{mm}$, $W \leq 0.2$, $N \leq 3$	MI
Metal Squash Dent /Flange(Front Side)	$D(W) \leq 1, L \leq 3, N \leq 3;$	MI
B/L High Voltage Wire Denudation	Not allowed	MA
Polarizer flaw or leak out resin	Defect is defined as the active area.	MI
Outline Dimension	Must in Spec, refer to related product spec.	MI

Product Specification

	Model: GVTW50TPFB1R0	Rev. No.	Issued Date.	Page.
		A	2016/02/18	23 / 24

9.1.4.2 Functional Inspection:

Item	Judgment Criteria			Classification
	Area(Note1)	I	O	
Point Defect	Bright dot	Random	2	
		2 dots adjacent	0	0
		3 dots adjacent or more	0	0
	Dark dot	Random	3	
		2 dots adjacent	0	
		3 dots adjacent or more	0	0
	Total Dot Defect		5	
	Distance	Distance between Bright and Bright dot	$L \geq 5\text{mm}$	
		Distance between Bright and Dark dot	$L \geq 5\text{mm}$	
		Distance between Dark dot	$L \geq 5\text{mm}$	
(1) It is defined as Point Defect if defect area $> 0.5\text{dot}$ (2) It is ignored if defect area $\leq 0.5\text{dot}$ (3) Weak point defect will be defined as Bright Dot if it can be observed through ND filter 5% (Full Screen Black Inspection)				
Line Defect	Obvious vertical or horizontal line defect is not allowed.			MA
Mura	Not allowed if it can be observed through ND Filter 5 %			MI
Foreign Material in spot shape *Note-3	$D \leq 0.2\text{mm}$: Ignored $0.2\text{mm} < D \leq 0.5\text{mm}$: $N \leq 8$ $D > 0.5\text{mm}$: Not allowed			MI
Foreign Material in line or spiral shape *Note-4	$W \leq 0.05\text{mm}$ or $L \leq 5\text{mm}$: Ignored $0.05\text{mm} < W \leq 0.2\text{mm}$ and $L 1.0\text{mm} \leq 5\text{mm}$: $N \leq 8$ $W > 0.2\text{mm}$ or $L > 5\text{mm}$: Not allowed			MI
Display Function Abnormal	No Malfunction can be allowed			MA

Product Specification



Model: GVTW50TPFB1R0

Rev. No.

Issued Date.

Page.

A

2016/02/18

24 / 24

Note-1 : I/O Area Definition

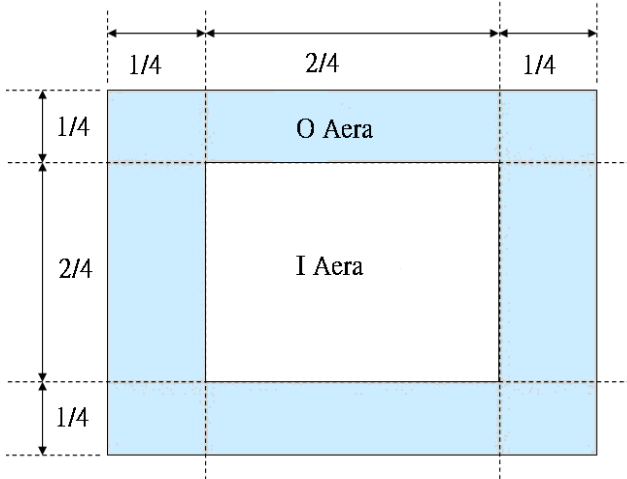

Note-2 : Polarizer Scratch

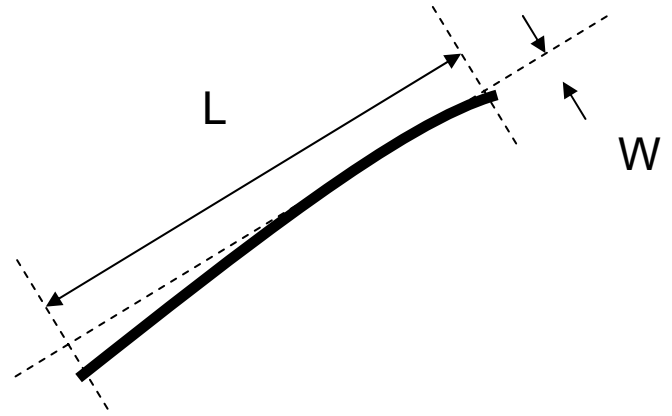

Note-3 : Spot Foreign Material
($W \geq L / 4$)

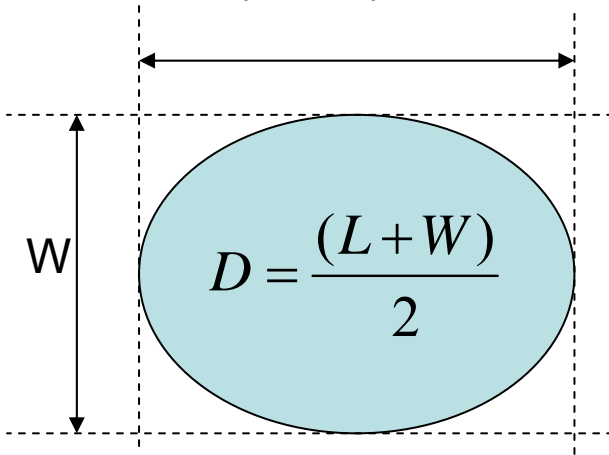

Note-4 : Line or Spiral Foreign Material
($W < L / 4$)

