

We connect · We Protect

We offer suitable solutions to meet customer's specific requirements

Application Note no.014

Patch Antenna Series

GPS Patch Antenna

PA1575MZ50XXG-XX-XX

Prepared	Checked	Approved
Da Fu Cheng	Yuan Piao Tseng	Jimmy Su



INPAQ Technology Co., LTD

<http://www.inpaq.com.tw>

TEL :+886-37-585-555

FAX : +886-37-585-511

Innovation · Nature ·

People · Advance · Quality

PA1575MZ50XXG-XX-XX Application Note

Catalog

Applications.....	2
Features.....	2
Electrical Characteristics (For Example: 1580 MHz).....	2
Antenna Dimensions (unit: mm).....	3
The Performance of Different Sizes GPS	3
The Performance of GPS on Different Ground Sizes	4
3D Radiation Patterns of GPS on Different Ground Sizes	4
Performance of GPS Antenna Located at Different Positions of PCB	5
Performance of GPS Antenna Located at Different Positions on Top of PCB Side.....	6
PND Applications	7
Mobile Phone Applications	11
GPS Antenna Module Application	15
Car Mount Application	16
Contact Information.....	18

Applications

This antenna is designed for GPS application and it's suitable for cellular phones, PDA, notebook, navigator, and all devices which have GPS function.

Features

- High directivity
- Square antenna size
- Low cost
- Lead free soldering compatible
- RoHS compliant
- Tray packing







Electrical Characteristics (For Example: 1580 MHz)

Electrical Specifications	
Center Frequency	1580 MHz
Bandwidth	6 ~ 27 MHz ($S_{11} \leq -10$ dB)
Polarization	RHCP
Ref. Impedance	50 ohm
Peak Gain	-0.05 ~ 5.0 dBic (typ.)@1580 MHz
Gain at 10° Elevation	-4.5 ~ -1 dBic (typ.)@1580 MHz
Size	12.8 x 12.8 x 4 mm ~ 25 x 25 x 4 mm





* Electrical characteristics depend on INPAQ evaluation board without matching circuit.

* The dimension of evaluation board is 30 x 30 mm ~ 70 x 70 mm.

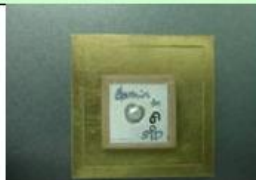

Antenna Dimensions (unit: mm)

Dimension (mm)	25x25x4	25x25x2	18.4x18.4x4	18.4x18.4x2
Photo				
Polarization	Circular	Circular	Circular	Circular
Dimension (mm)	15x15x4	13x13x4	12x12x3.5	
Photo				
Polarization	Circular	Circular	Circular	

The Performance of Different Sizes GPS

Dimension (mm)		25x25x4		18.4x18.4x4		15x15x4	
Test on 30x30 mm ground plane							
Gain (dBic)	Bandwidth (MHz)	2.7	10	2.3	8.1	1.3	6.9
Dimension (mm)		25x25x2		18.4x18.4x2			
Test on 30x30 mm ground plane							
Gain (dBic)	Bandwidth (MHz)	1.4	7.1	-0.4	7.3		

The Performance of GPS on Different Ground Sizes

Test Ground Size (mm)	Photo	Total RHCP Efficiency (%)	Upper Hemi-sphere RHCP Efficiency (%)	Gain (dBic)
70x70		83.1	75.5	5.5
50x50		60.3	54.2	4.2
40x40		49.4	43.5	2.8
30x30		42.1	35.9	1.6

This test is an example of using a 25 x 25 x 4 mm patch antenna. Other sizes patch antennas have similar trend.

3D Radiation Patterns of GPS on Different Ground Sizes

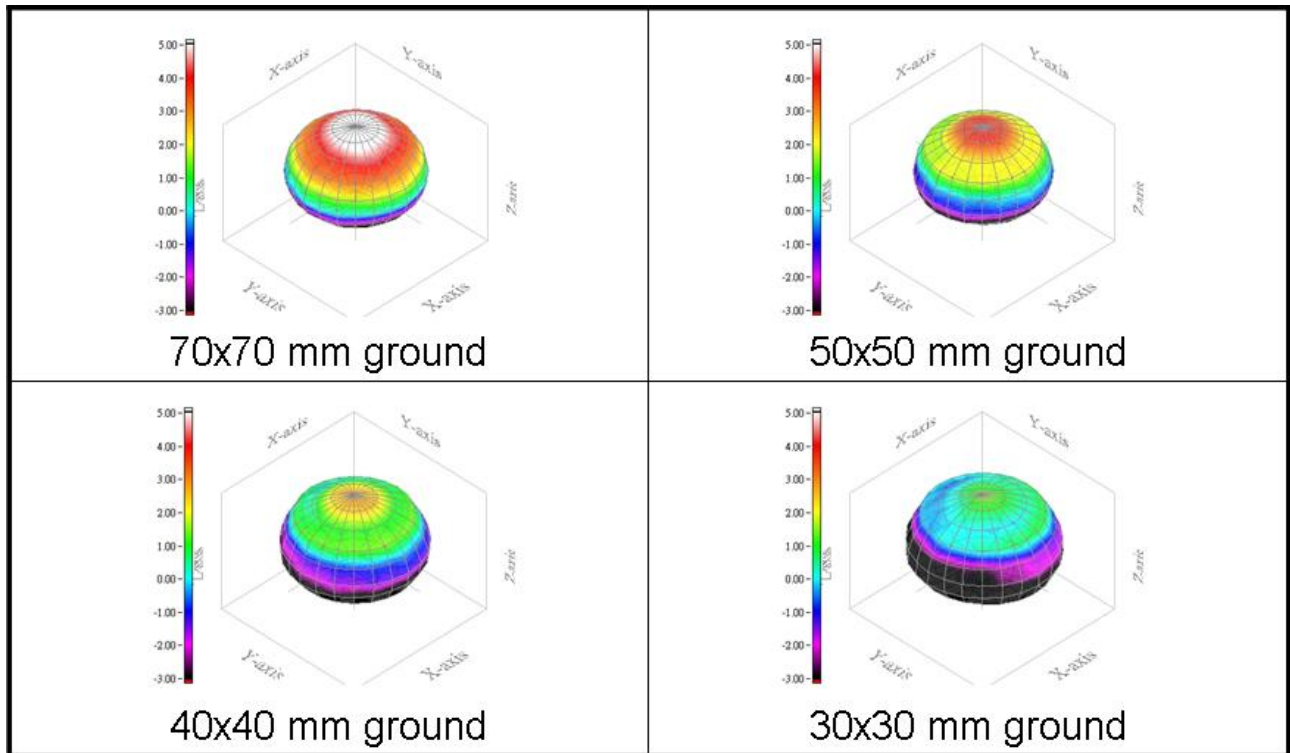

This test is an example of using a 25 x 25 x 4 mm patch antenna. Other sizes patch antennas have similar trend.

Performance of GPS Antenna Located at Different Positions of PCB

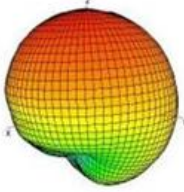
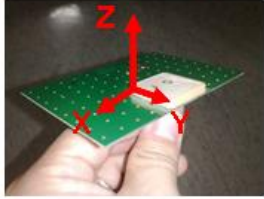
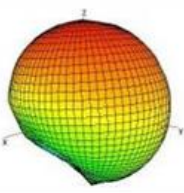
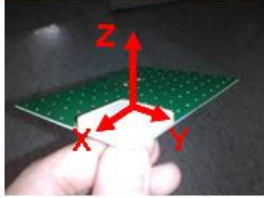
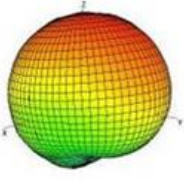
Location	Photo	3D Gain pattern	Gain at zenith (dBic)	Efficiency (%)
Left			4.1	72.8
Middle			4.7	80.8
Right			4.3	72.3

This test is an example of using a 25 x 25 x 4 mm patch antenna on a 65 x 95 mm ground plane. Other sizes patch antennas have similar trend.

Performance of GPS Antenna Located at Different Positions on Top of PCB Side

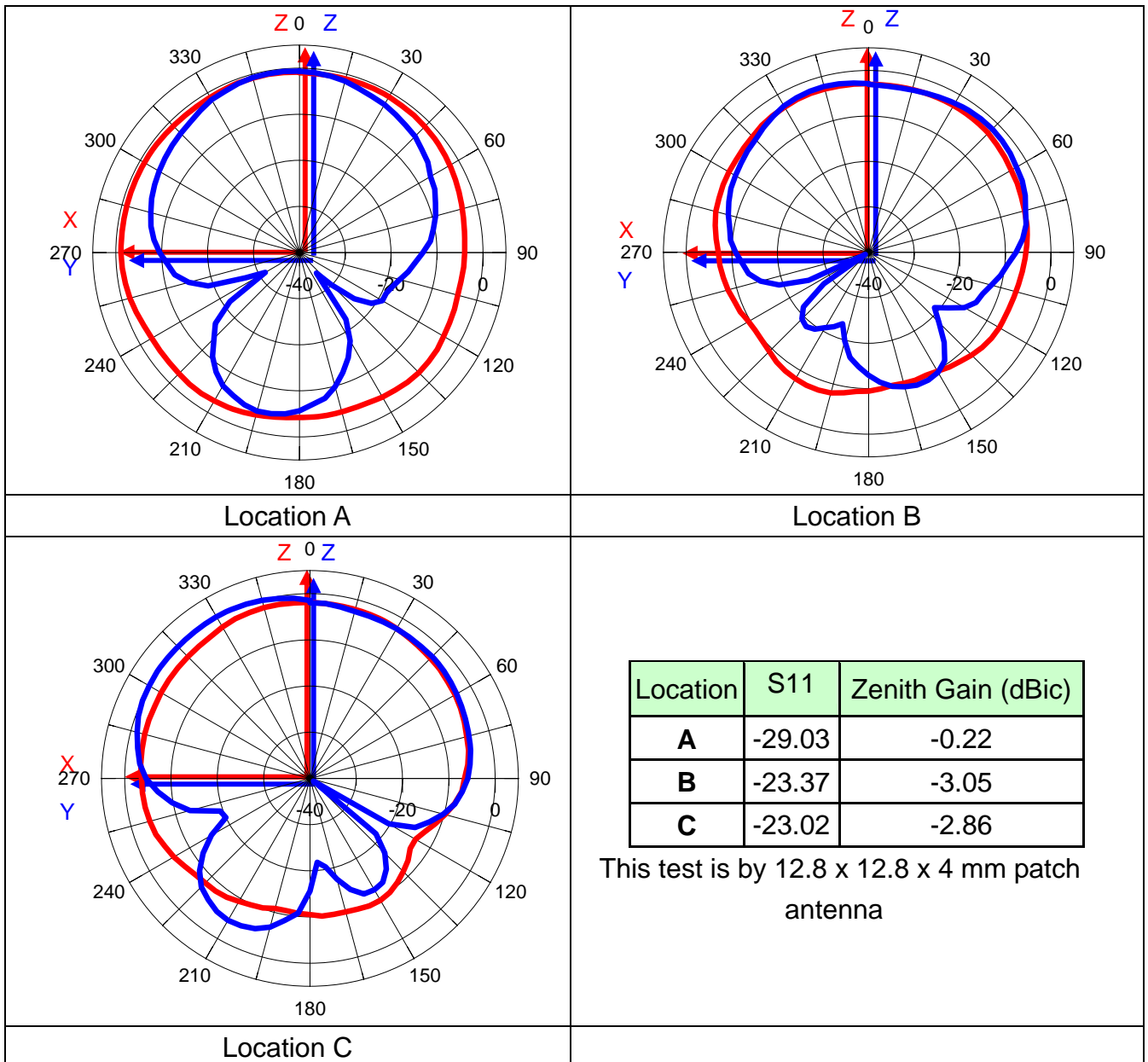
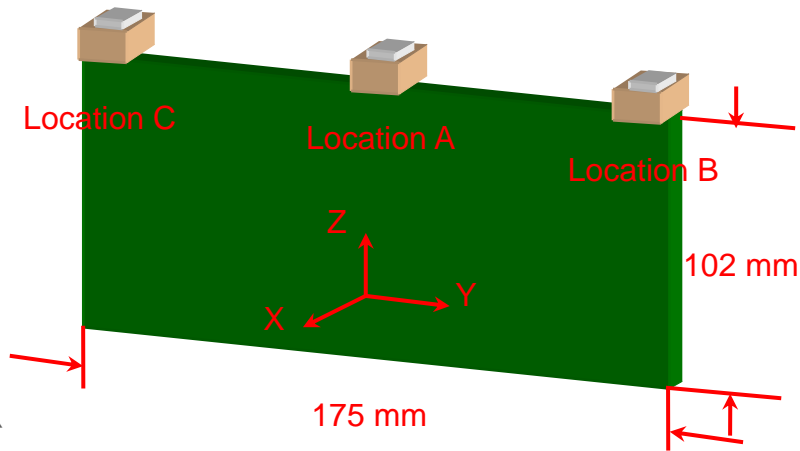

PND Applications

For the PND or Navigator applications, GPS antenna is usually placed at the long side of PCB or back side of PCB. Larger and thinner GPS antenna is suggested using on back side of PCB. Please notice that the GPS antenna is not recommended to place under where the rack located unless there are no metal inside the rack. In the other way, the GPS antenna is sitting at the long side of PCB. In this case, a smaller GPS patch antenna locating at the center of long side of PCB is suggested. Larger ground plane for GPS will make better performance. These two type arrangements of GPS antenna can receive about 90 degree direction signals in the car.

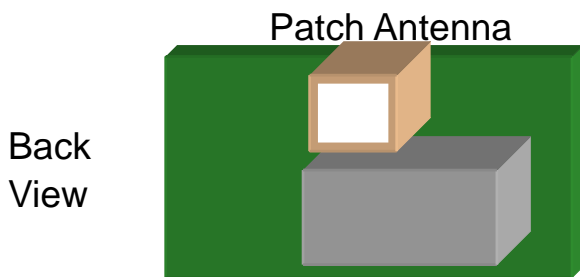
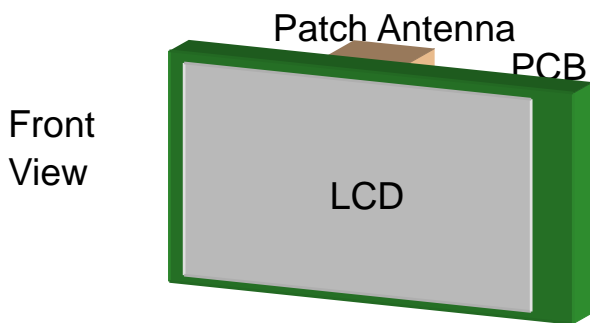

On Back
Large size CP patch

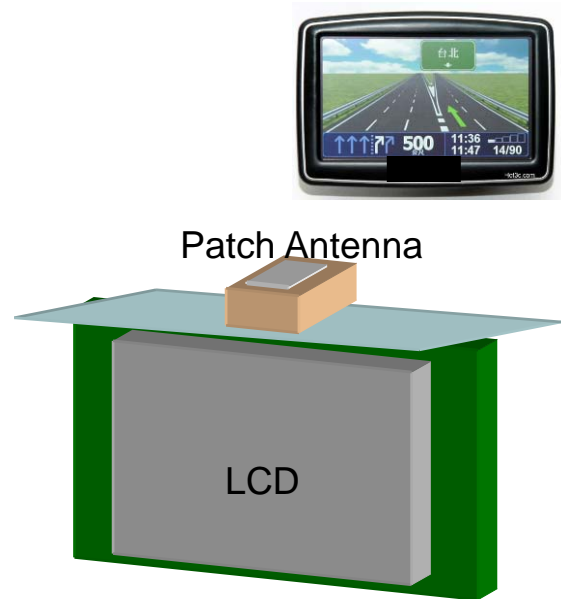

On Top
Small size CP patch

GPS Patch Antenna on Back Side of PCB

A. The metal with GPS patch antenna location

Metal to GPS patch antenna top side $\geq 2\text{ mm}$

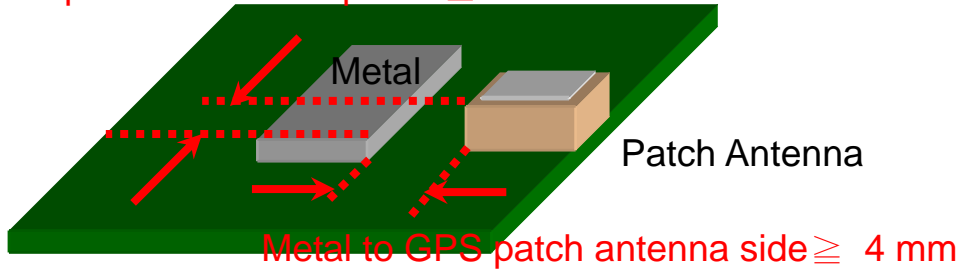

B. The PND or Navigator housing

Don't cover the metal paint.

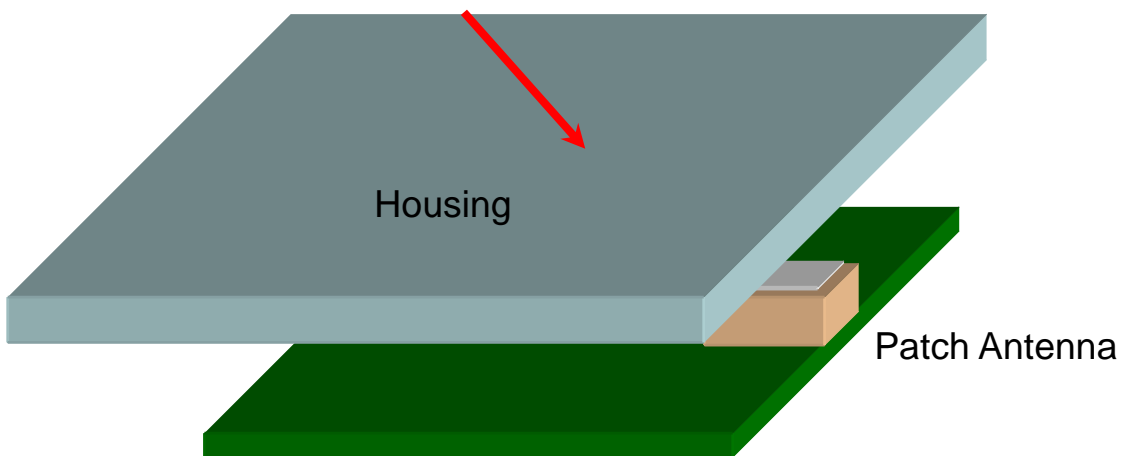

C. The rack with GPS patch antenna location

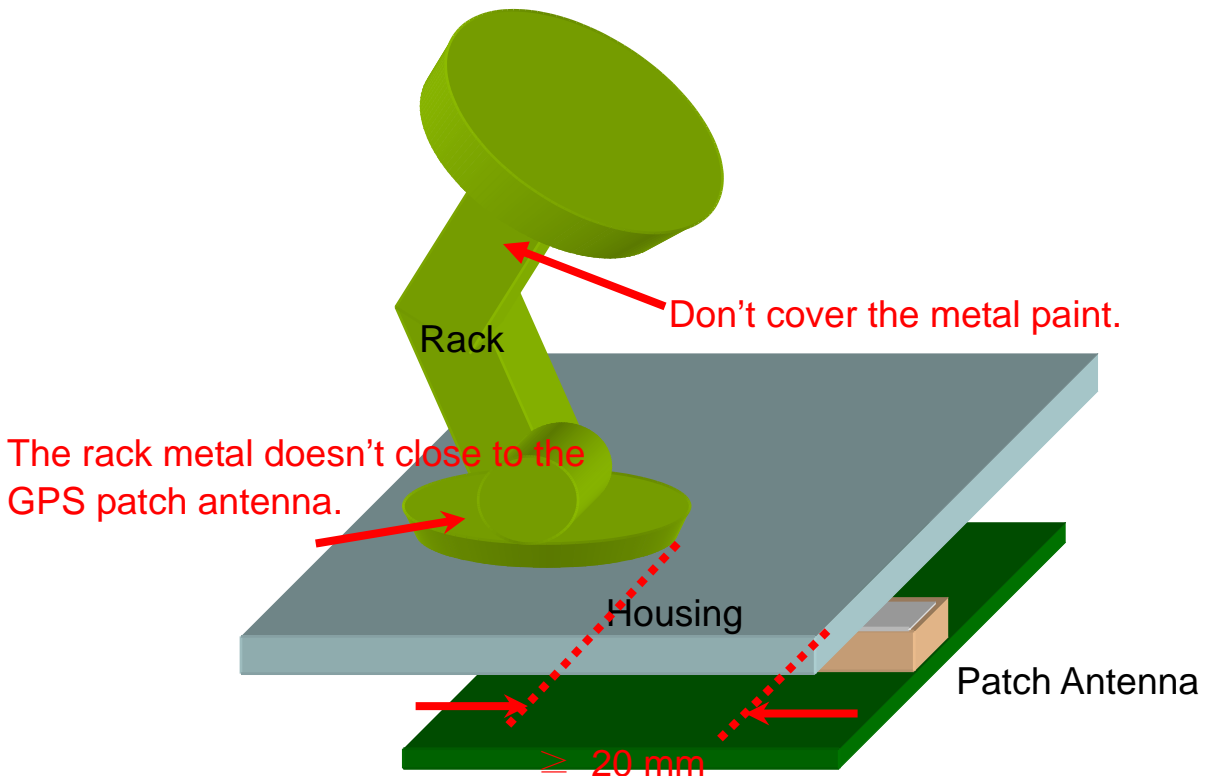

GPS Patch Antenna at Long Side of PCB

A. The patch antenna inside PND at top location environment

Width must be larger than patch antenna

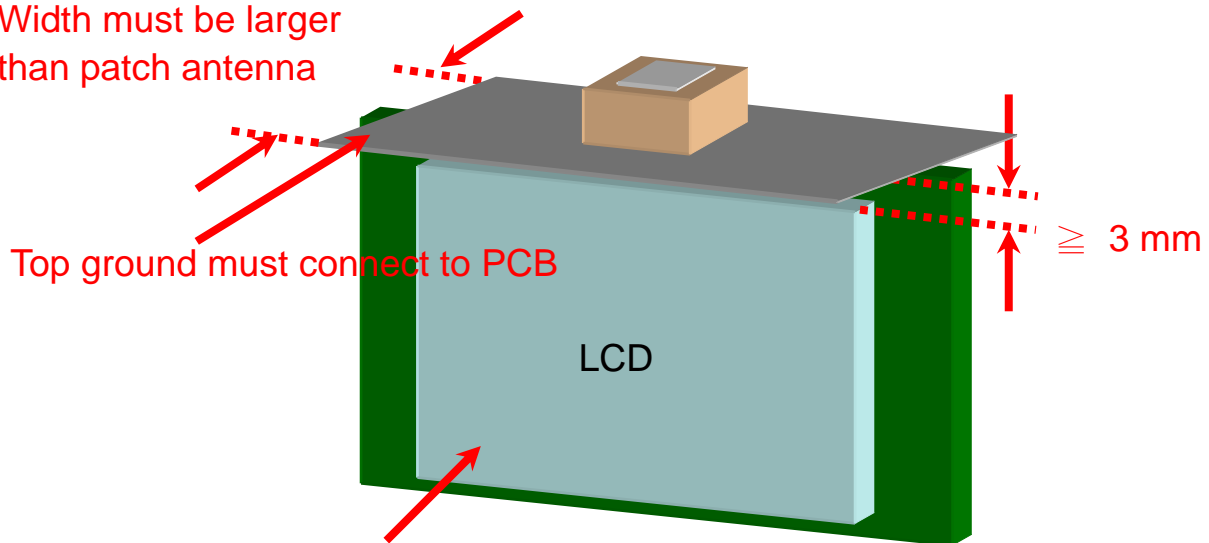

Top ground must connect to PCB

LCD can use conductive gasket to connect to PCB to extend the ground plane

B. The PND or Navigator housing

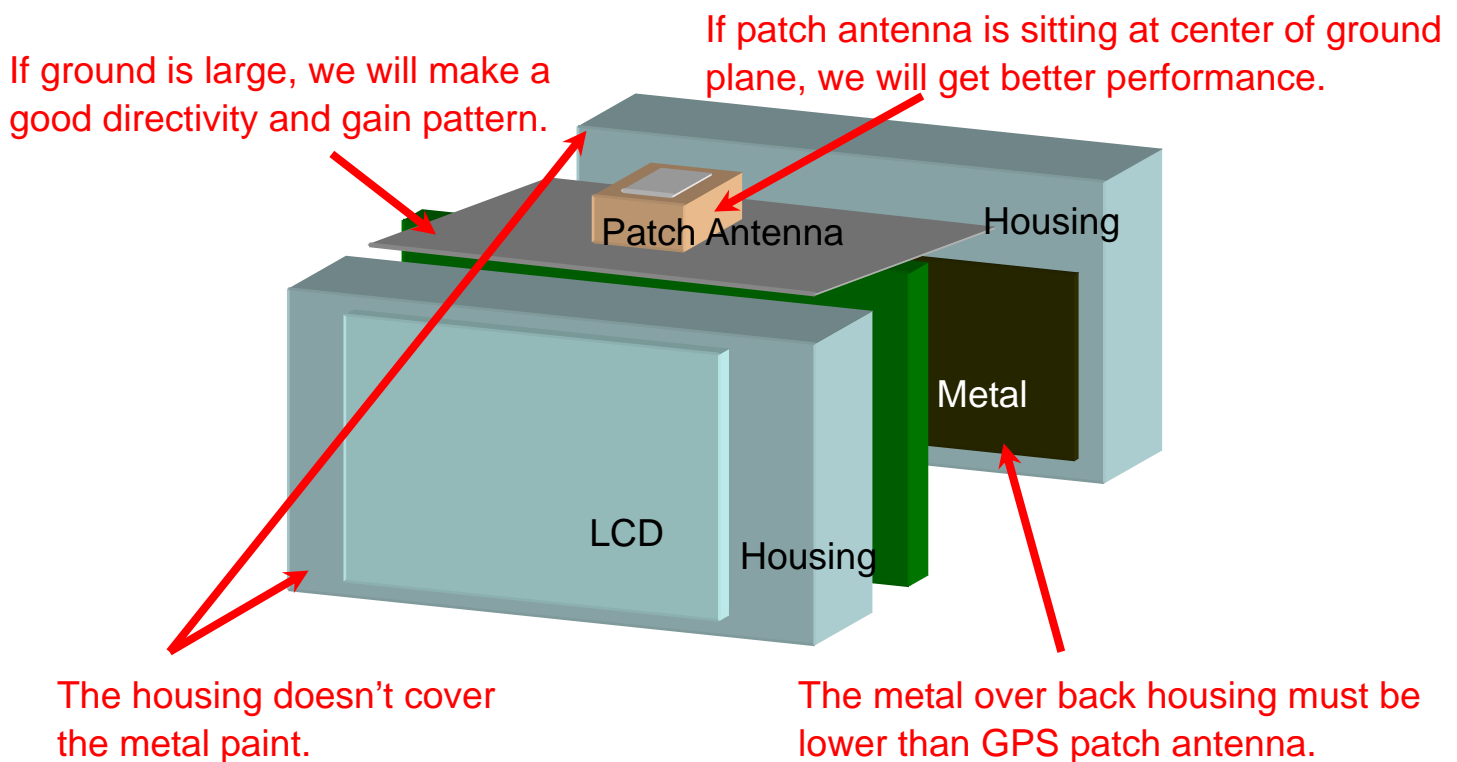

PND GPS Patch Antenna Pattern

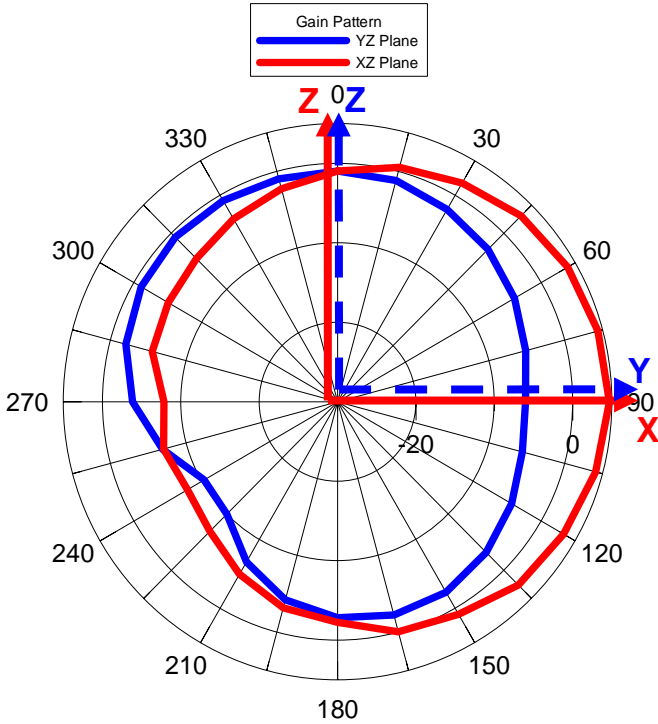

Circular Polarization 2D Gain Pattern

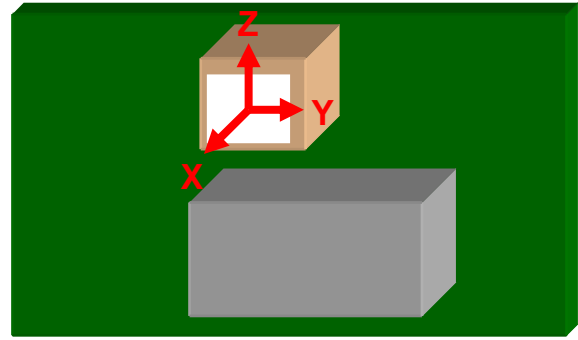

The maximum antenna gain point to X direction, and gain in zenith is still good. This orientation is especially suitable for PND mounted under the front window of the car, can avoid wasting antenna sensitivity from car roof, and focus more to front window.

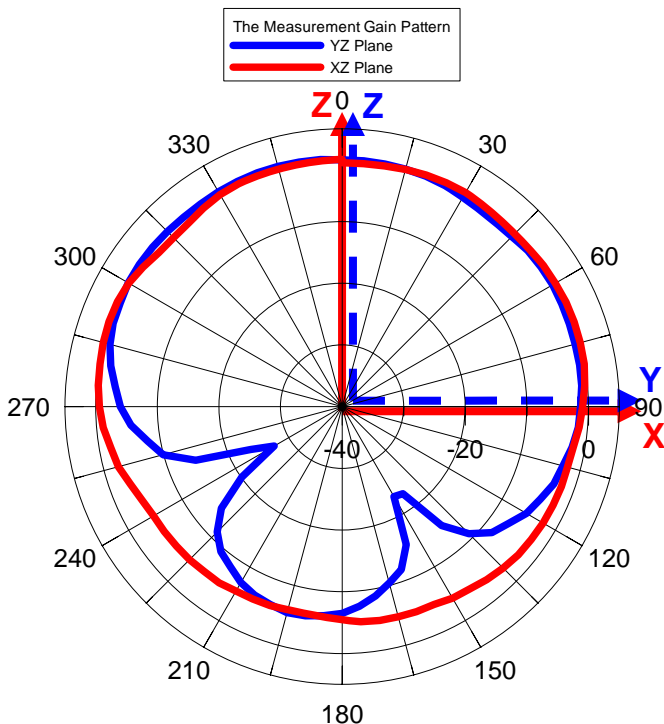

Circular Polarization 2D Gain Pattern

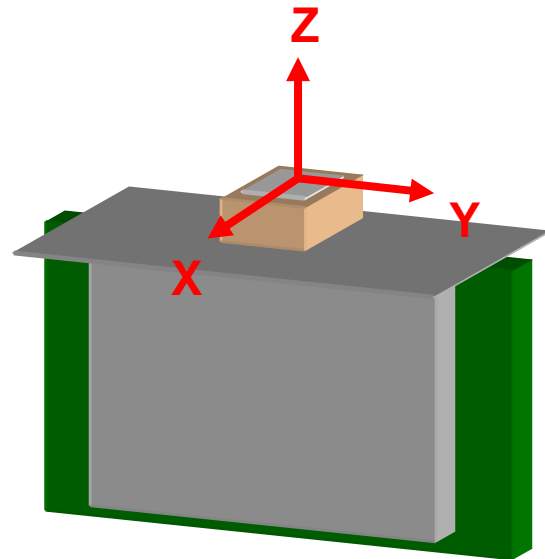

The antenna gain is good and more average in all angles to sky. This orientation is suitable for both car mounted and handheld PND devices.

Mobile Phone Applications

For mobile phone applications, GPS antenna usually places at the top side of PCB. It always sits at top center and top side of mobile phone. Because mobile phone is thinner, a smaller GPS patch antenna is more suitable to fit inside. The GSM antenna sometimes locates at top back side of mobile phone. We must notice the GPS and GSM antenna isolation, because GPS and GSM frequency is very close. If it is possible, we recommend the GSM antenna can be located at the opposite side of PCB to GPS patch antenna. The speaker and camera sometimes increase some noise, so we need some space to divide them to GPS patch antenna.

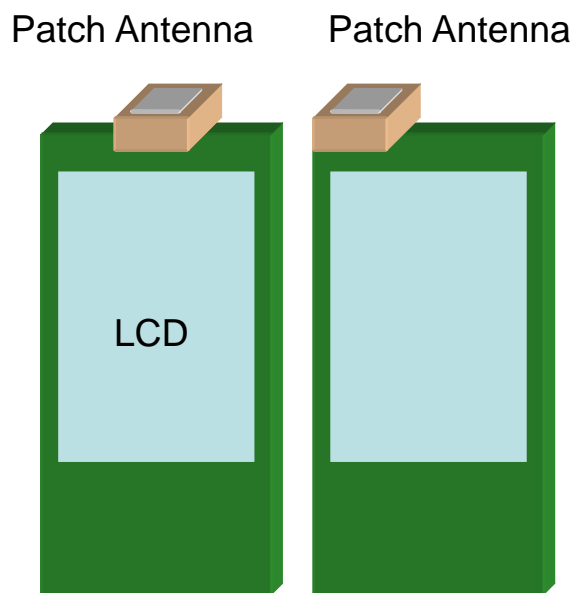

**Small size RHCP
patch**

A. The patch antenna at top center location environment

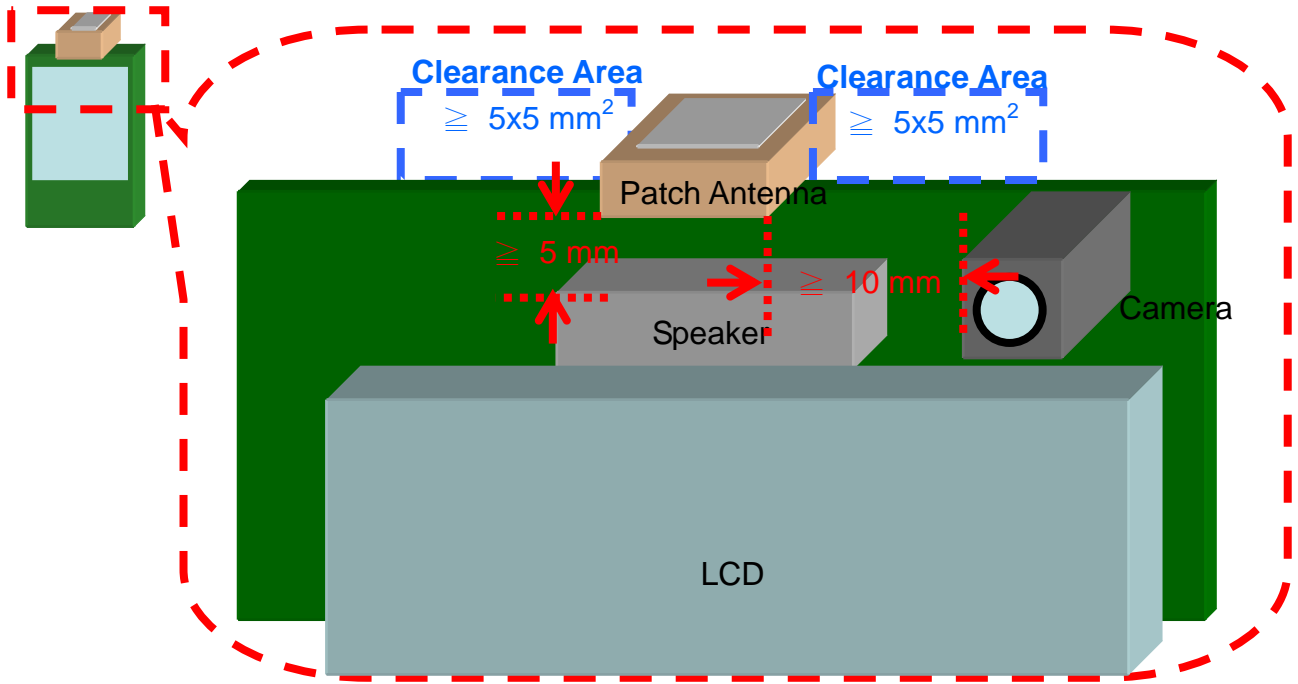

B. The patch antenna at top side location environment

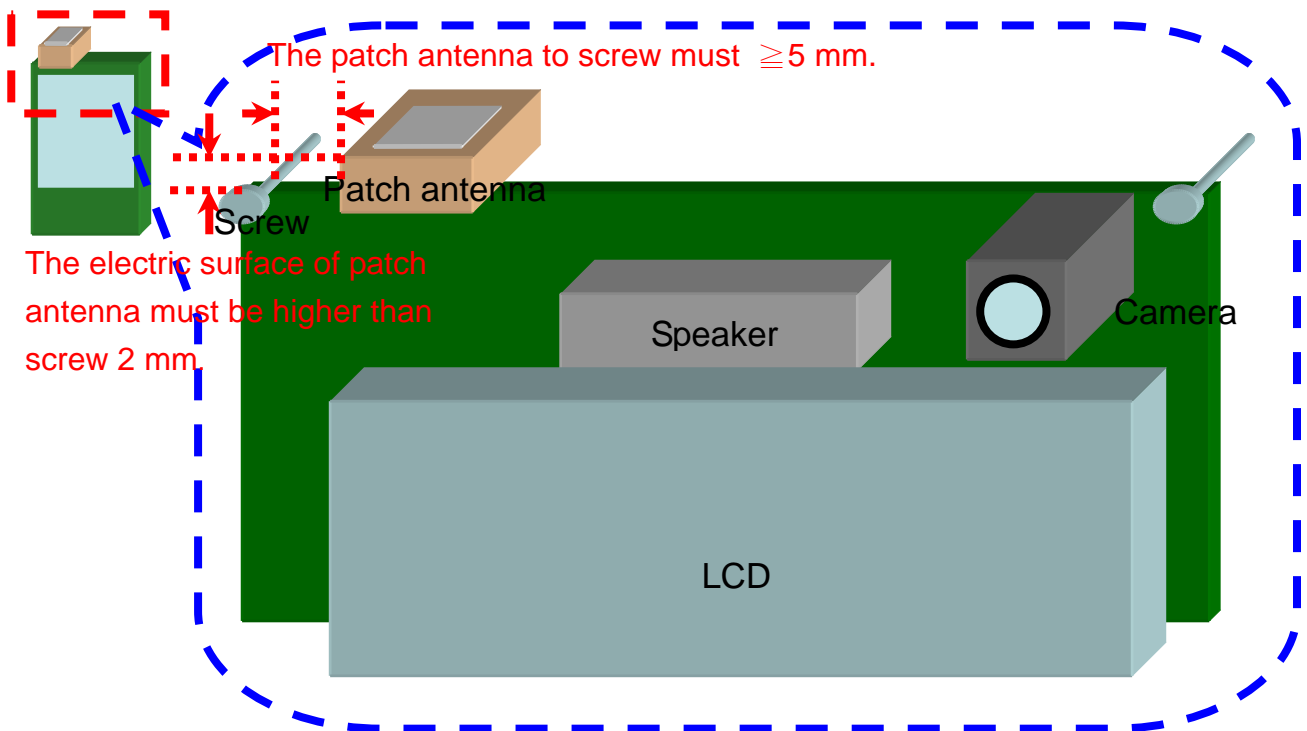

C. The GSM and GPS Location in Mobile Phone

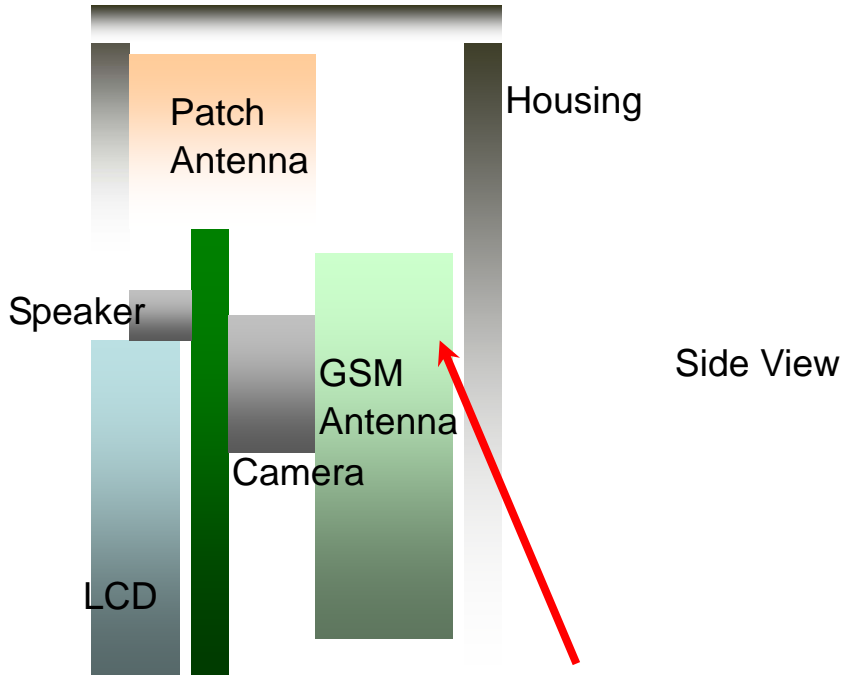

If GSM antenna and GPS antenna locate very close, we suggest GSM antenna can locate under GPS antenna. Please notice the isolation between GPS and GSM antenna.

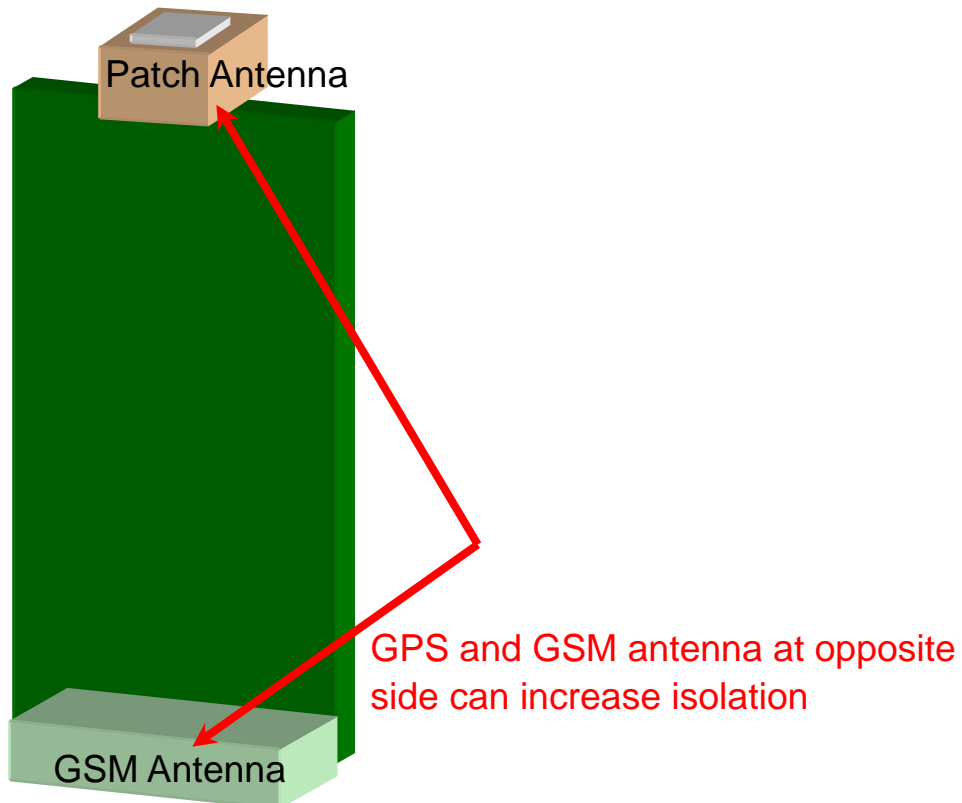

Mobile Phone GPS Patch Antenna Pattern

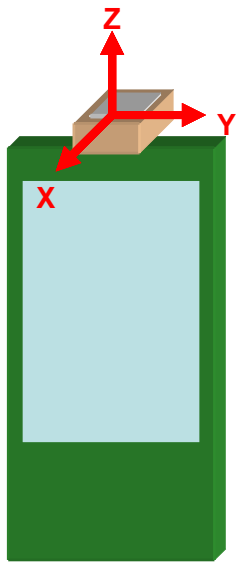

YZ plane gain pattern is symmetrical

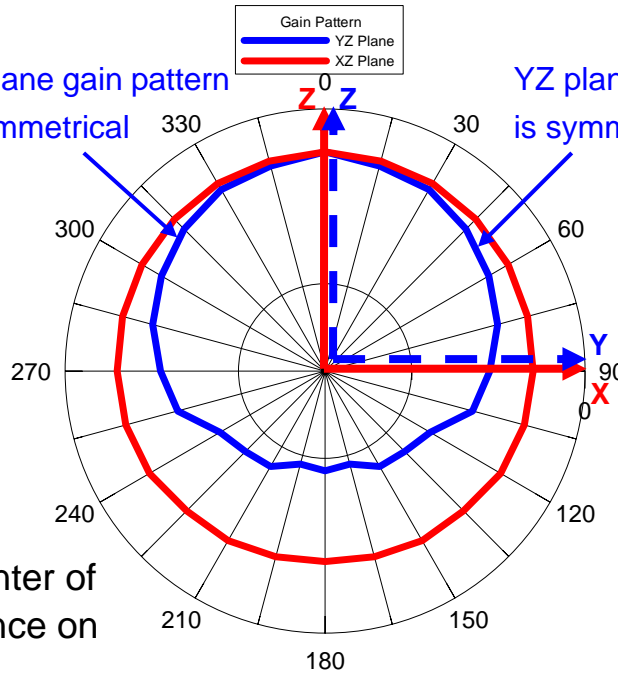

YZ plane gain pattern is symmetrical

Antenna located at the center of edge has better performance on radiation pattern direction

Circular Polarization 2D Gain Pattern

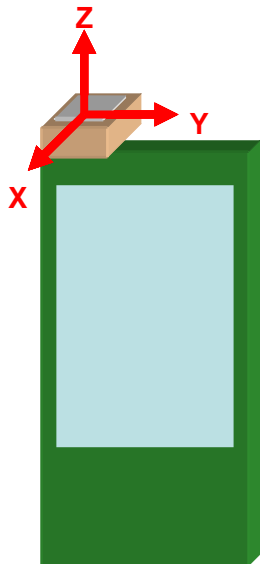

YZ plane gain pattern is NOT symmetrical

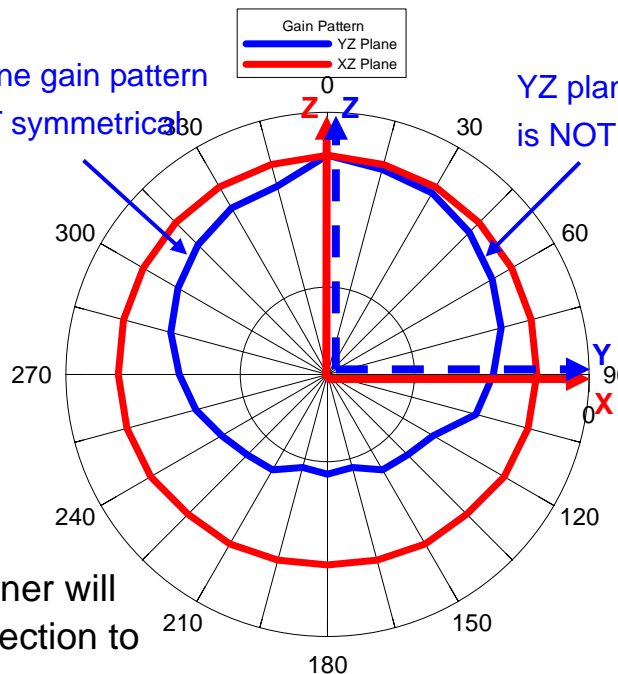

YZ plane gain pattern is NOT symmetrical

Antenna located at left corner will tilt the radiation pattern direction to right side

Circular Polarization 2D Gain Pattern

GPS Antenna Module Application

In the GPS antenna module, we combine the GPS patch antenna and LNA module together. This GPS antenna module is using a RF cable to connect to the GPS system. This GPS antenna module can get better signal than a passive patch antenna connecting to a RF cable to LNA then link to GPS system. In the GPS antenna module, please notice the direction of a RF cable and the RF connector. This GPS antenna module can be embedded inside to the housing of PDA or mobile phone.

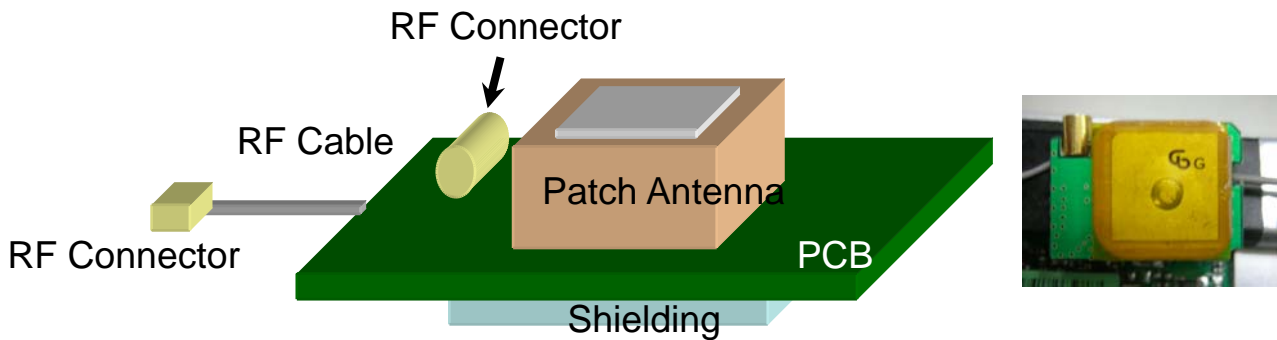

GPS Active Antenna Module

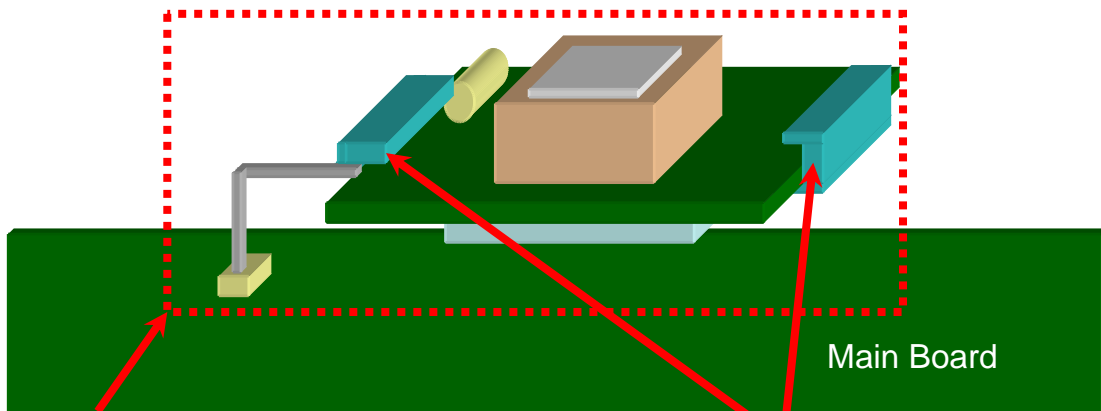

Prefer example: Patch antenna + LNA + RF cable can get a better signal.

GPS module must be fixed

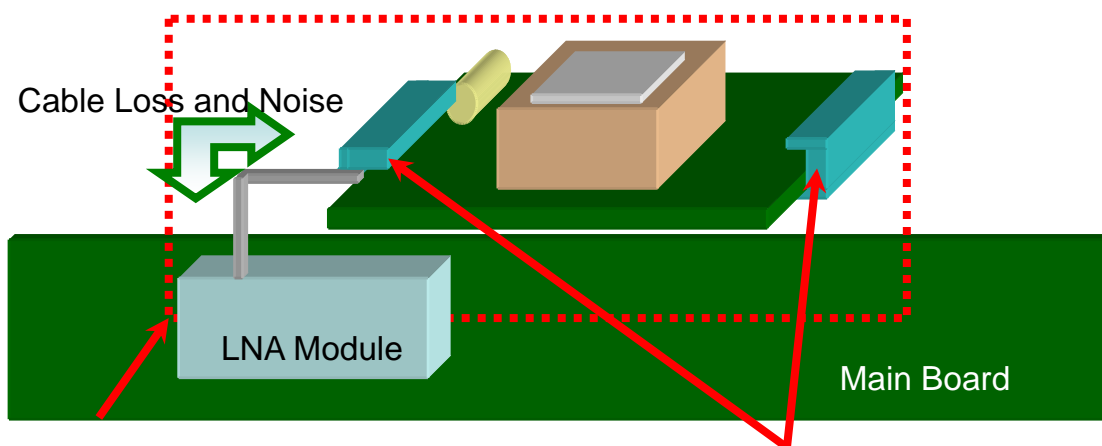





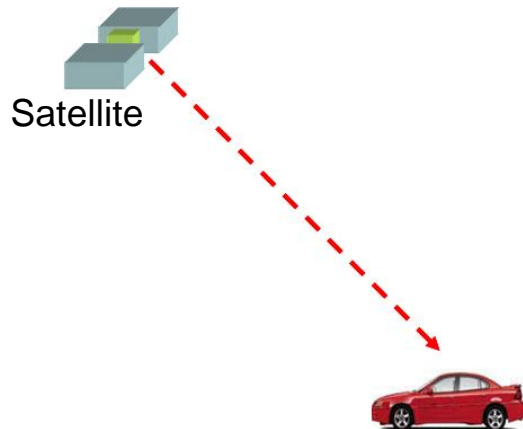

Non-prefer example: Patch antenna + RF cable + LNA will have extra cable loss and possible noise

GPS module must be fixed

Car Mount Application

In car mount application, we can use the GPS active antenna to mount on a car (GPS10D, GPS03B, GPS05K, GPS01F or GPS02F). This GPS active antenna includes the patch and LNA. It can be located on the top of a car or under the windshield of a car. If we set the GPS active antenna on the top of a car, we will have best antenna performance. In order to conceal the GPS active antenna, there are also many manufacturers locating this active antenna under the windshield or inside the dashboard.



Category	Picture	Description	Product Name	Size(mm)	Application
GPS Antenna		GPS Active Antenna	GPS03B	45x45x14.5	GPS, Navigation Device
GPS Antenna		GPS Active Antenna	GPS10D	37.5x34.5x12.5	GPS, Navigation Device
GPS Antenna		GPS Active Antenna	GPS05K	37.4x34x12.95	GPS, Navigation Device
GPS Antenna		GPS/GSM Combo Antenna Module	GPS01F	83x52x61	GPS/GSM, Navigation Device
GPS Antenna		GPS/GSM Combo Antenna Module	GPS02F	83x52x61	GPS/GSM Navigation Device

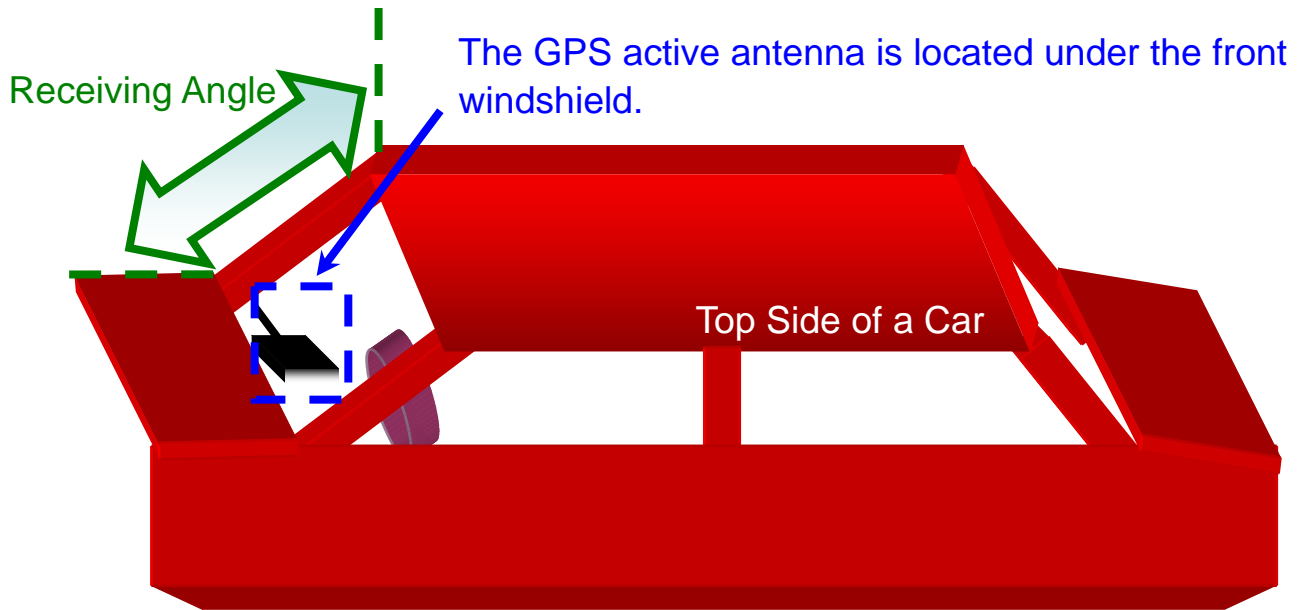
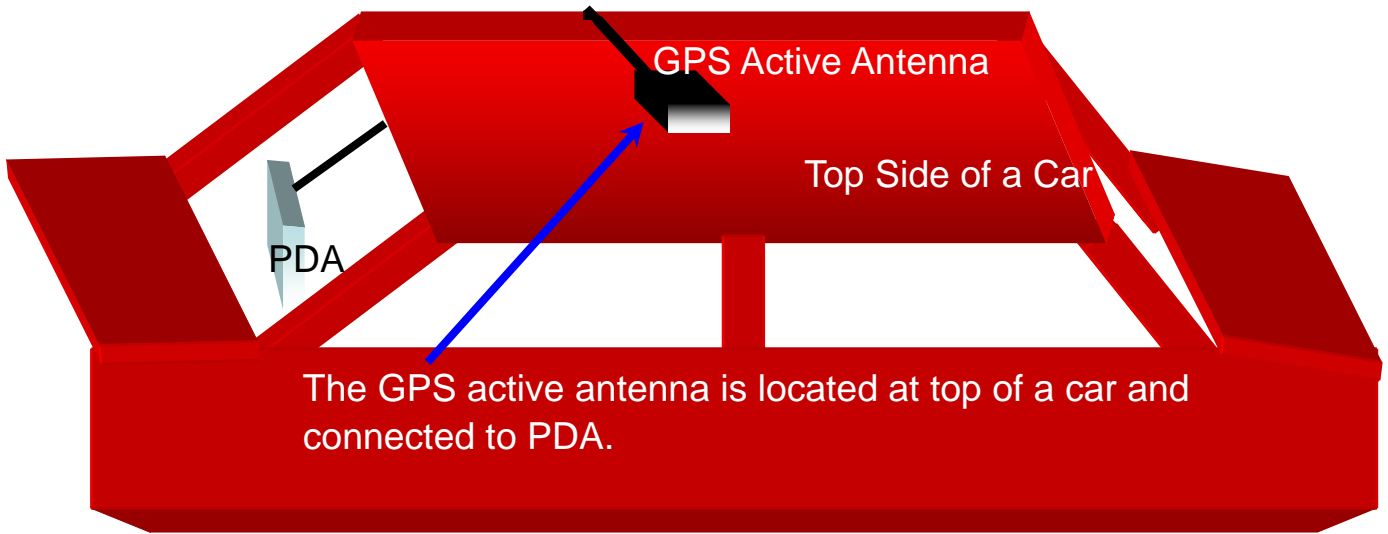

Contact Information

INPAQ Technology Co, LTD

Taiwan Chunan

ADD: No.11, Ke-Yi St., Chunan, Miaoli 35059, Taiwan (R.O.C.)

TEL : +886-37-585-555

FAX : +886-37-585-511

E-Mail : info@inpaq.com.tw

Web site : <http://www.inpaq.com.tw>

USA Office

ADD: 21 Echo Brook Road, Rochester, NH 03839, U.S.A.

TEL:+1-603-332-6222

FAX:+1-603-509-2900

Korea Office

ADD: 221 Raemian Seocho Univill, 1445-4, Secho-Dong, Secho_gu, Seoul, Korea
130-070

TEL:+82-2-584-8959

FAX:+82-2-584-8951

